

phase pendant installation guide

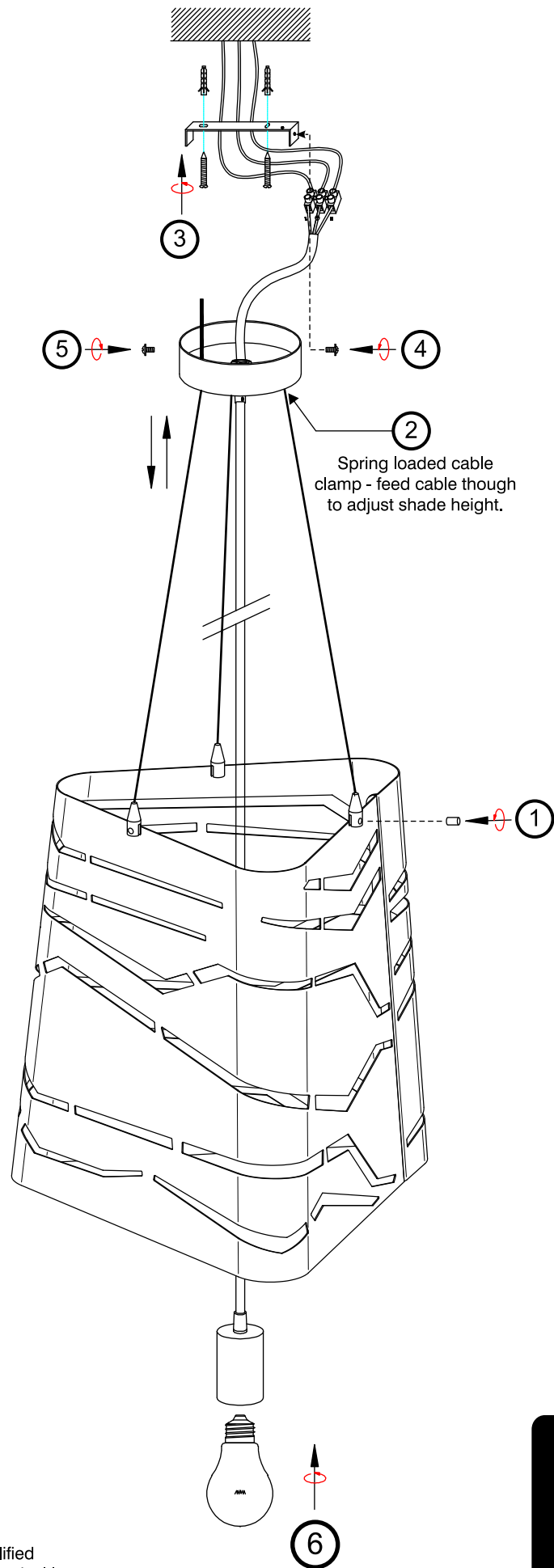

Max. 60W ES Lamp
Line voltage must be installed by a qualified
Electrician, in accordance with local electrical laws

1/66 McLachlan Street Fortitude Valley Q 4006
p +61 7 3252 1633 f +61 7 3252 1766
info@luxxbox.com www.luxxbox.com

