



WEDGE THOUGHTBOARD (LX-WTB)

Wedge Thoughtboard forms part of Luxxbox's Agile Board range. The slim, elegant ThoughtBoard is a quiet achiever with loud results. The magnetic whiteboard surface serves many purposes, helping you to organise your life or office in style. With the addition of the sound absorbency panel, the ThoughtBoard can also help hush open-plan spaces, creating a little slice of calm. High quality double castors enable easy movement on all flooring surfaces.

KEY BENEFITS

- Only GECA certified agile whiteboard on the market
- Magnetic whiteboard with optional laminate backing
- Superior quality writing surface
- Use multiple ThoughtBoards to create a straight or curved room divider
- High quality lockable castors for ease of movement, concealed to remove trip hazard
- Ships flat, easy to assemble, short lead times
- Non-magnetic option available
- All version include internal shelf

SIZE

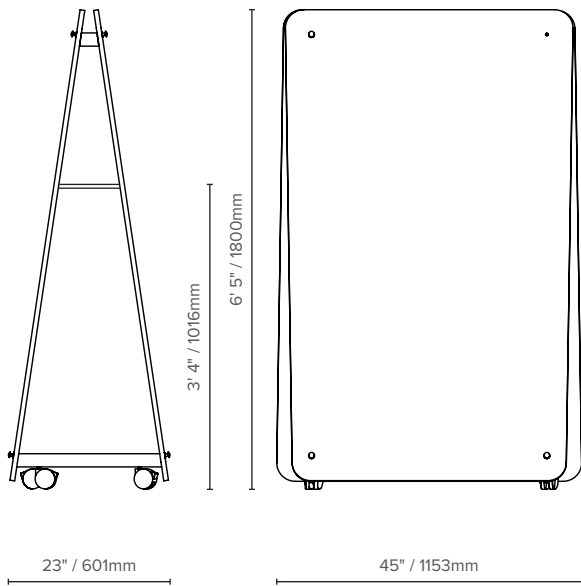

ORDER CODE

EXAMPLE: LX - WTB - Y - O - W - 1LG, 4, 5A

(Luxxbox Wedge Thoughtboard, Magnetic, Oak, White, Small Pin Board-Light Grey, Pen Holder,

LX - WTB								
PRODUCT CODE	MAGNETIC		INTERIOR COLOR		OPTIONAL ACCESSORIES			
	WTB	Y N	Yes No	O B W	Oak Veneer Black Veneer White	1 2 3 4	Small Pin Board* Large Pin Board* Flip Chart Bracket Pen Holder	5A 5B 6 7

(*For Pin Board accessory option, please specify color code alongside (eg: 1LG, 2Y)

Straight room divider

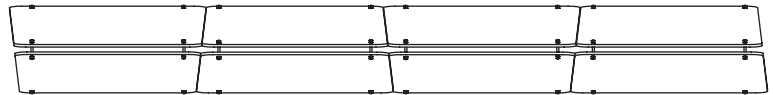

Curved room divider

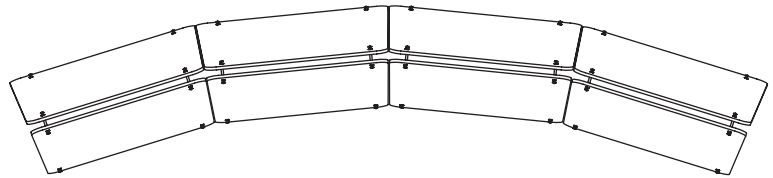

AVAILABLE COLORS

Colors are subject to lead times and variations across batches

INTERIOR COLOR

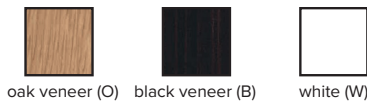

PIN BOARD COLOR

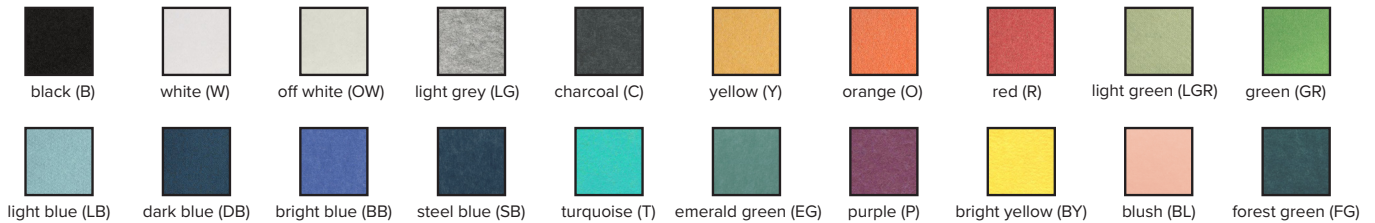

Luxxbox reserves the right to change the specification, material and colours at any time without notice. Standard warranty terms and conditions apply. All rights reserved. © August 2019 Ver 3.5
All dimensions and values on specification sheet are nominal.



LUXXBOX USA INC × (P)+1 (415) 871 0448 × USA@LUXXBOX.COM
LUXXBOX PTY LTD × (P)+61 7 3257 2822 × INFO@LUXXBOX.COM
WWW.LUXXBOX.COM



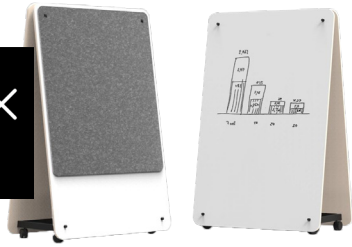

WEDGE THOUGHTBOARD (LX-WTB)

ACCESSORIES

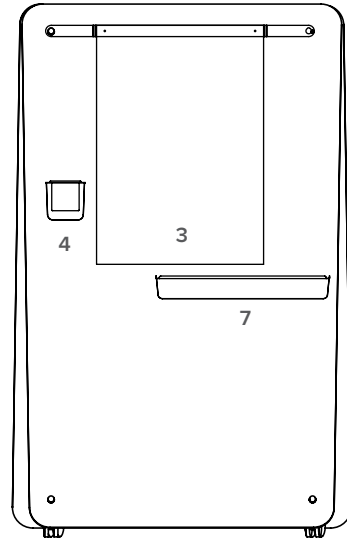
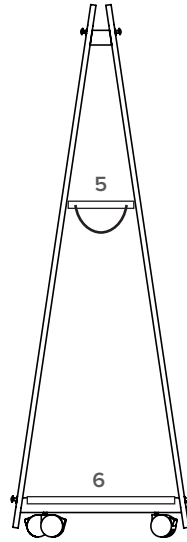
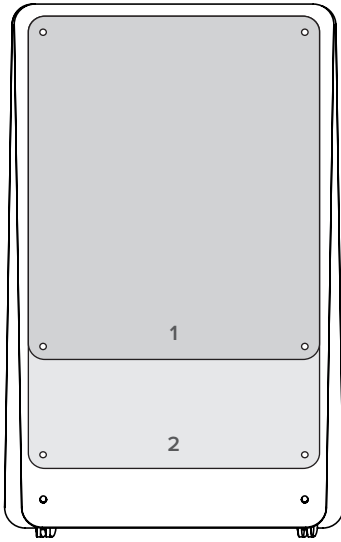

(1) SMALL PIN BOARD

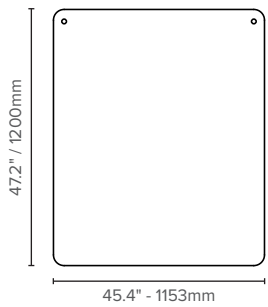

(2) LARGE PIN BOARD



(3) FLIP CHART BRACKET

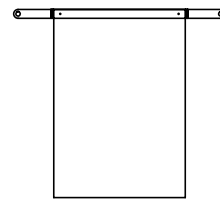

(4) PEN HOLDER

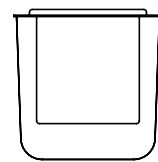

(6) BASE TRAY



(5) INTERNAL TRAY

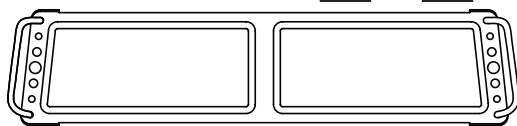

(7) PEN SHELF

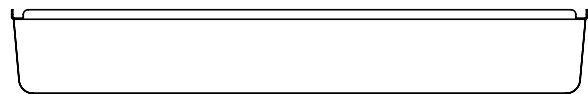

Luxxbox reserves the right to change the specification, material and colours at any time without notice. Standard warranty terms and conditions apply. All rights reserved. © August 2019 Ver 3.5
All dimensions and values on specification sheet are nominal.



LUXXBOX USA INC × (P)+1 (415) 871 0448 × USA@LUXXBOX.COM
LUXXBOX PTY LTD × (P)+61 7 3257 2822 × INFO@LUXXBOX.COM
WWW.LUXXBOX.COM

