

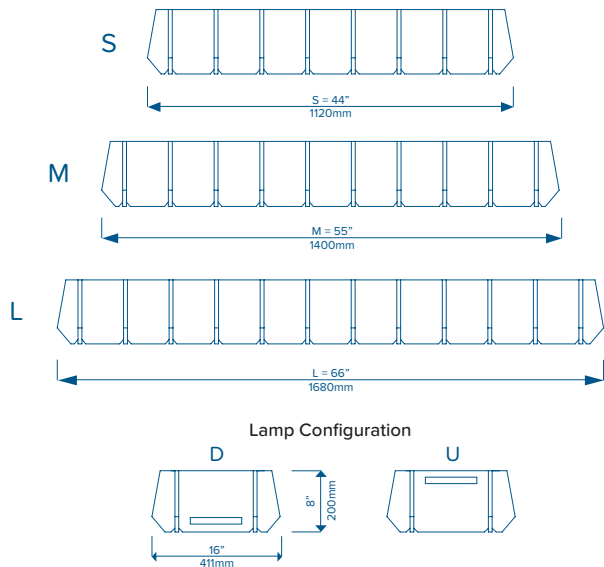

MATRIX



The rectangular array of cleverly interconnected acoustic panels of Luxxbox's Matrix combines visual appeal with effective sound management to help hush open spaces. Available as individual units in 3 different sizes or interconnected run lengths for infinite cool

KEY FEATURES

- Available in 3 sizes and a wide range of colors
- Segments made from 0.3" acoustic panels
- Also available as continuous run lengths
- Highly effective sound absorption: Class D NRC 0.45 - Class C NRC 0.70
- 4 Suspension cables, 9' total length, height adjustable
- Supplied with 9.8' woven power cable
- Suitable for indoor environments
- Class A, FS:5 - SD:25 fire rated (USA)
- Minimum 65% recycled material
- IES files available
- ELV dimming compatible
- Acoustic properties independently tested

HOW TO SPECIFY

LX-MA = (Configuration) - (Colour) - (Distribution) - (Dimming) - (Voltage)

Size	Shade Color	Color temperature	Light Distribution	Dimming	Voltage
S = 44" W x 16" D x 8" H	Specify color	30 = 3000k	D = Down	ELV = ELV compatible ¹	120V
M = 55" x 16" D x 8" H		35 = 3500k	U = Up	0-10V ²	277V ³
L = 66" x 16" D x 8" H		40 = 4000k			

Example: LX-MA-S-GR-U-ELV-120V = Luxxbox Matrix, small, green, up light, ELV dimming, 120V

¹ ELV dimming not available on 277V configurations

² 0-10V Dimming options available upon request

³ 277V options available upon request using remotely mounted stepdown transformer

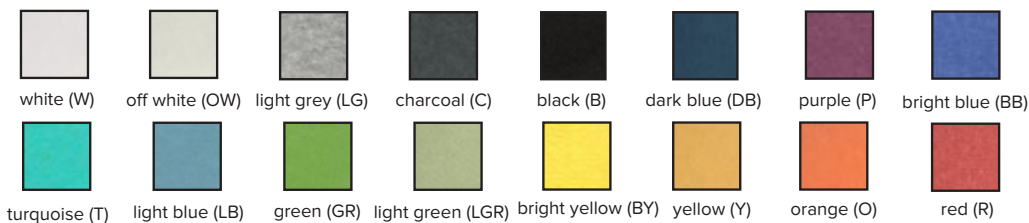

Luxxbox reserves the right to change the specification, material and colors at any time without notice. Standard warranty terms and conditions apply. All rights reserved. © October 2018 Ver 3.0

LUXXBOX PTY LTD × ACN 123 193 788 × 43 KENYON ST EAGLE FARM QLD 4009 AUSTRALIA
 P +61 7 3257 2822 × INFO@LUXXBOX.COM × LUXXBOX.COM × P +1 (415) 871 0448 × USA@LUXXBOX.COM





MATRIX INFINITE

Choose any standard size Matrix and stack to create run lengths for infinite cool. Interconnected runs of up to 10 meters provide the perfect solution for lighting corridors and hallways, whilst acting as a means of sound management.

Component Configurations

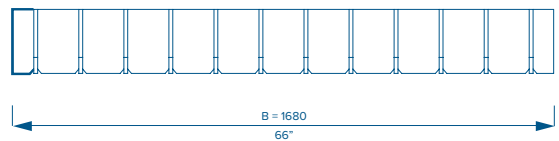
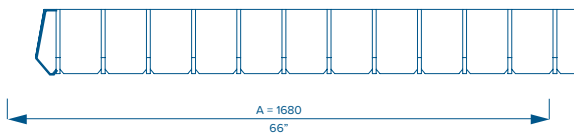

Component Configurations Example (132")

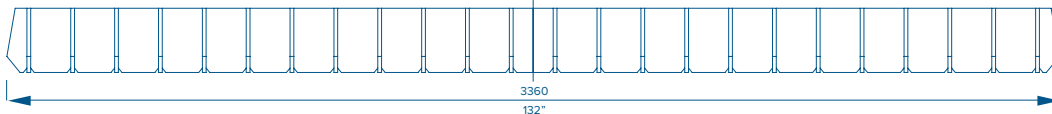

HOW TO SPECIFY

LX-MA = (Size) - (Color) - (Color temperature) - (Distribution) - (Dimming) - (Voltage)

Component config	Shade Color	Color temperature	Light Distribution	Dimming	Voltage
AA = Minimum config		30 = 3000k	D = Down	ELV = ELV compatible	120V
ABA	Specify color	35 = 3500k	U = Up		
ABBA *		40 = 4000k			

Example: LX-MA-I-ABBA-BB-30-U-ELV-120V = Luxxbox Matrix Infinite, 132" long, bright blue, 3000K, up light distribution, ELV compatible, 120VAC

* Add additional Bs to create custom length
nb: Additional power cords may be necessary

Luxxbox reserves the right to change the specification, material and colors at any time without notice. Standard warranty terms and conditions apply. All rights reserved. © October 2018 Ver 3.0

LUXXBOX PTY LTD × ACN 123 193 788 × 43 KENYON ST EAGLE FARM QLD 4009 AUSTRALIA
P +61 7 3257 2822 × INFO@LUXXBOX.COM × LUXXBOX.COM × P +1 (415) 871 0448 × USA@LUXXBOX.COM





MATRIX

LIGHT SOURCE SPECIFICATIONS

All Matrix LED luminaires are equipped with LED boards of the following specification:

- S – 7200 lumen, 120VAC, CRI 80, 80W
- M – 9600 lumen, 120VAC, CRI 80, 106W
- L – 12000 lumen, 120VAC, CRI 80, 133W

DIMMING OPTIONS

100%-10% dimming is compatible with the following ELV dimmers:

- Lutron Nova NLV-600-WH
- Lutron Maestro MAELV-600-WH
- Lutron Diva DVELV-303P-WH
- Leviton VIZIA + Decora Cat-NO.VPE06-1LZ
- Leviton Decora DSE06-10Z
- Leviton Illumatech Slide Dimmer IPE04-1LZ

LUMINOUS INTENSITY DISTRIBUTION

Small

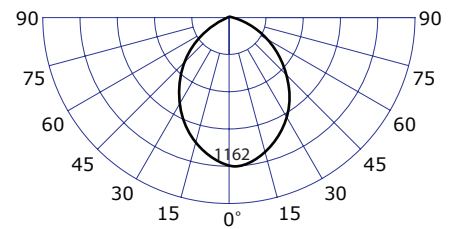

Medium

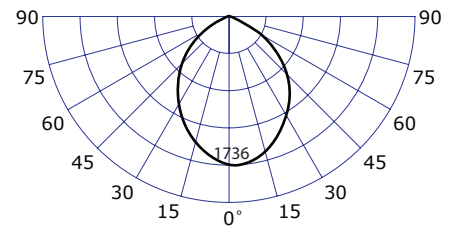

Large

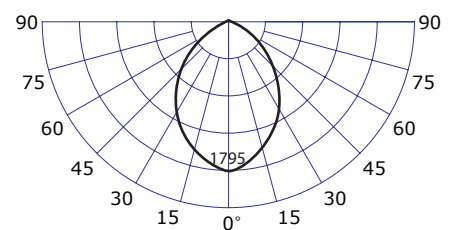

Luxxbox reserves the right to change the specification, material and colors at any time without notice. Standard warranty terms and conditions apply. All rights reserved. © October 2018 Ver 3.0

LUXXBOX PTY LTD × ACN 123 193 788 × 43 KENYON ST EAGLE FARM QLD 4009 AUSTRALIA
 P +61 7 3257 2822 × INFO@LUXXBOX.COM × LUXXBOX.COM × P +1 (415) 871 0448 × USA@LUXXBOX.COM





MATRIX

CANOPY LOCATIONS

Small

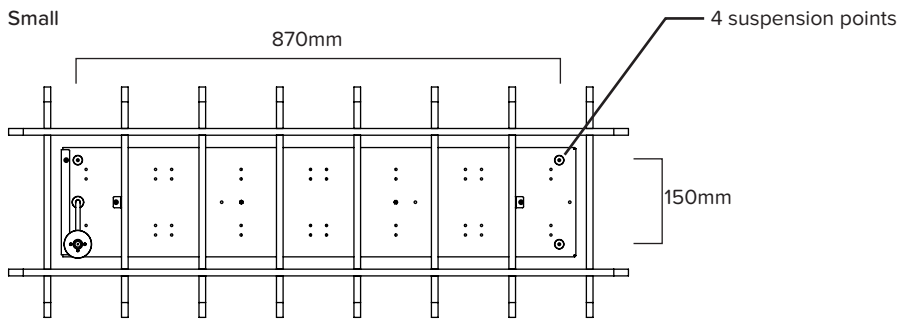

Medium

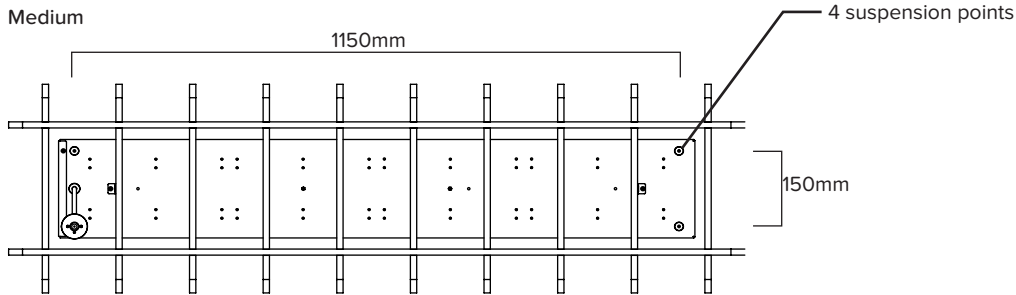

Large

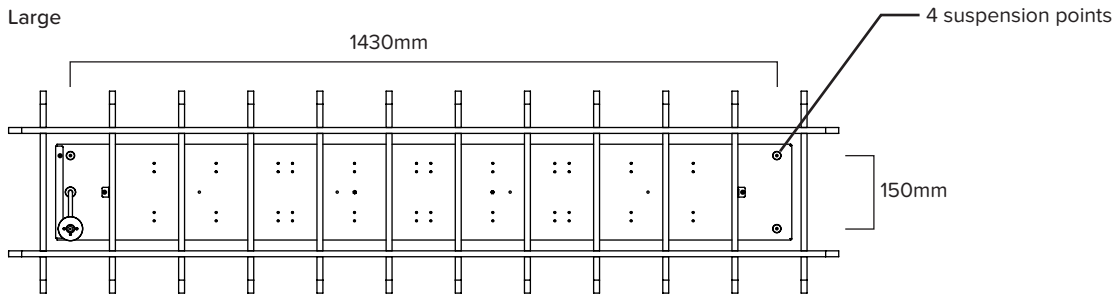

Luxxbox reserves the right to change the specification, material and colors at any time without notice. Standard warranty terms and conditions apply. All rights reserved. © October 2018 Ver 3.0

LUXXBOX PTY LTD × ACN 123 193 788 × 43 KENYON ST EAGLE FARM QLD 4009 AUSTRALIA
 P +61 7 3257 2822 × INFO@LUXXBOX.COM × LUXXBOX.COM × P +1 (415) 871 0448 × USA@LUXXBOX.COM



LUXX
 BOX

MATRIX INSTALLATION

⚠ Before starting, determine which fasteners will be best suited to secure the fitting, based on the material of the ceiling substrate.

1. Licensed electrician to terminate '120v AC input' and 'dimming input' to remotely mounted LED driver
2. Hang shade from ceiling using mounting hardware provided. See next page for additional detail
3. Mount canopy base to ceiling
4. Insert 'DC out' power cable into canopy cover. Adjust lengths of cable and trim if necessary. Fasten power cable strain relief grub screw. Connect DC power to terminals provided in canopy
5. Place canopy over canopy mount and fasten 3 x grub screws

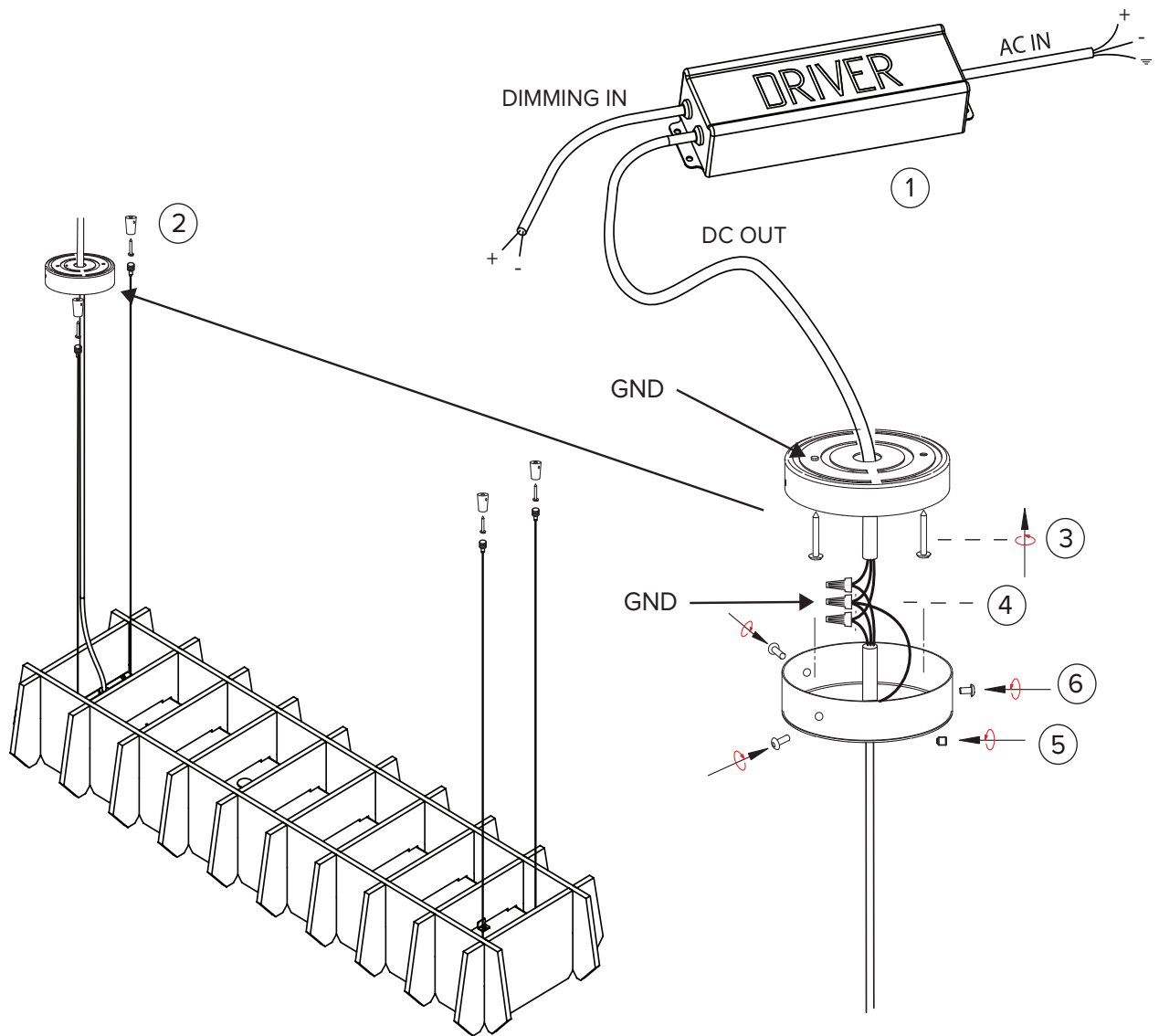

Note: Line voltage must be installed by a qualified electrician, in accordance with local electrical laws.

Luxxbox reserves the right to change the specification, material and colors at any time without notice. Standard warranty terms and conditions apply. All rights reserved. © October 2018 Ver 3.0

LUXXBOX PTY LTD × ACN 123 193 788 × 43 KENYON ST EAGLE FARM QLD 4009 AUSTRALIA

P +61 7 3257 2822 × INFO@LUXXBOX.COM × LUXXBOX.COM × P +1 (415) 871 0448 × USA@LUXXBOX.COM



LUXX
BOX

STANDARD CEILING MOUNT – INSTALLATION

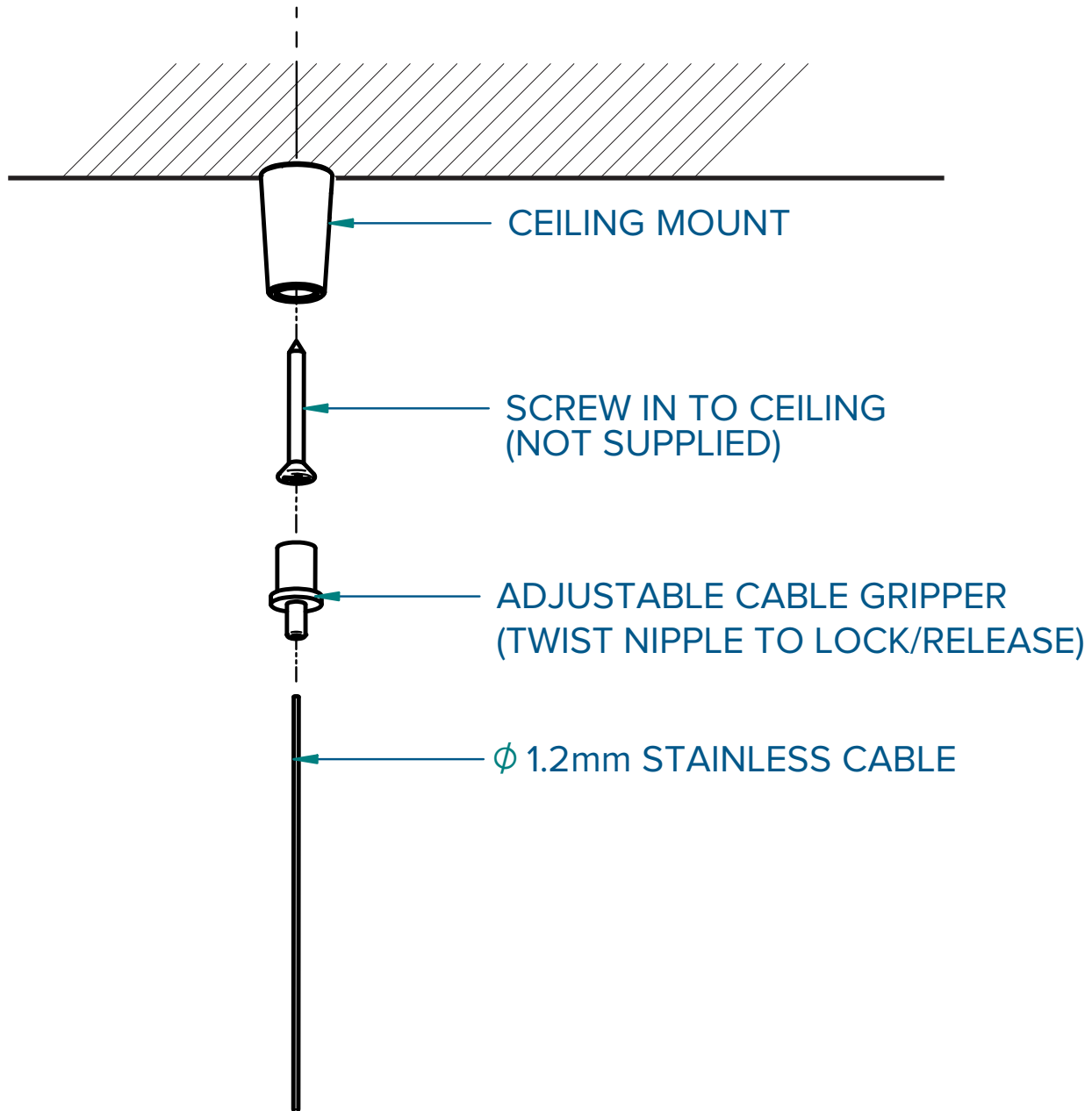

Luxxbox reserves the right to change the specification, material and colors at any time without notice. Standard warranty terms and conditions apply.
All rights reserved. © October 2018 Ver 3.0

LUXXBOX PTY LTD × ACN 123 193 788 × 43 KENYON ST EAGLE FARM QLD 4009 AUSTRALIA

P +61 7 3257 2822 × INFO@LUXXBOX.COM × LUXXBOX.COM × P +1 (415) 871 0448 × USA@LUXXBOX.COM



LUXX
BOX

STANDARD CEILING MOUNT - INSTALLATION



← Masonry plug, wall mate or similar - type to be determined by installer. Not supplied.



← Ceiling mount, Supplied

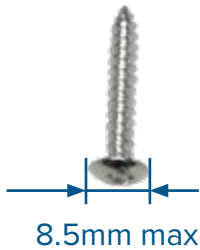

← Screw in to ceiling substrate - type to be determined by installer. Not Supplied



← Cable gripper with grip lock nipple. Supplied.



← 1.2mm Stainless suspension cable. Supplied.



Shown assembled

Luxxbox reserves the right to change the specification, material and colors at any time without notice. Standard warranty terms and conditions apply. All rights reserved. © October 2018 Ver 3.0

LUXXBOX PTY LTD × ACN 123 193 788 × 43 KENYON ST EAGLE FARM QLD 4009 AUSTRALIA
P +61 7 3257 2822 × INFO@LUXXBOX.COM × LUXXBOX.COM × P +1 (415) 871 0448 × USA@LUXXBOX.COM



LUXX
BOX