

WEDGE THOUGHTBOARD ACOUSTIC (LX-WTA)

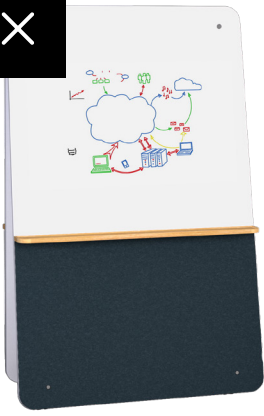

The Wedge ThoughtBoard Acoustic offers a slice of calm for any space. High-quality whiteboard surface offers a streak-free writing experience, with sound absorbing acoustic material close to the ground to dampen noise in high traffic areas. The magnetic surface hosts a suite of collaborative accessories, while the permanent pen shelf helps you organise your space in style. High-quality castors enable easy movement on all surfaces, concealed for extra safety in open spaces. Multiple Wedge ThoughtBoards Acoustic panels can be used in unison to create a curved or straight room divider.

KEY BENEFITS

- Superior quality ceramic steel writing surface
- Choice of laminate backing
- Use multiple ThoughtBoards to create a straight or curved room divider
- High quality lockable castors for ease of movement, concealed to remove trip hazard
- Ships flat, easy to assemble, short lead times
- Non-magnetic option available
- All versions include internal shelf
- Only GECA certified agile whiteboard on the market
- Base and Pinboard available in Motif collection

SIZE

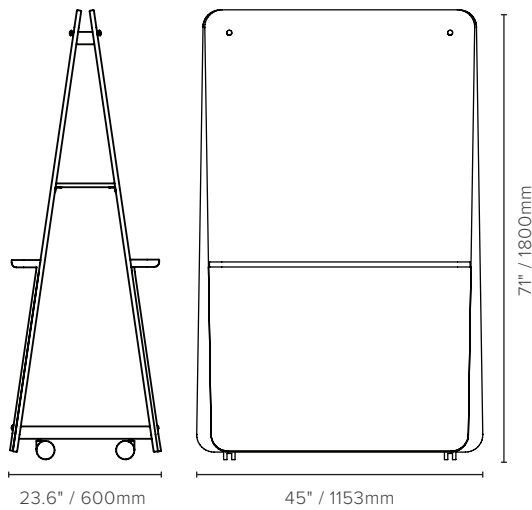

ORDER CODE

EXAMPLE: LX - WTA - Y - W - W - S - EG - 1LG - 4

(Luxbox WTB Acoustic, Magnetic, White interior, White Edges, Standard internal shelf, Acoustic Base in Light Green, Acoustic Board in Light Grey, Base Tray)

LX - WTA	MAGNETIC		INTERIOR COLOUR		EDGE COLOUR		INTERNAL SHELF		ACOUSTIC BASE COLOUR	OPTIONAL ACCESSORIES	
	Y	Yes N No***	O	B	W	S	PT	PB		1	2
WTA			Oak Veneer	Black Veneer	Black	White	Standard	Premium Timber	Use colour codes as shown	Acoustic Board A*	Acoustic Board B*
			White	White	White		Premium Black	Flip Chart Bracket		Pen Holder**	Base tray

(*For Acoustic Board accessory option, please specify color code alongside (eg: 1LG)

(**Pen Holder is only available for the Magnetic option)

(***Warranty terms for non-magnetic option differs from magnetic)

DIVIDER EXAMPLES

Straight room divider

Curved room divider

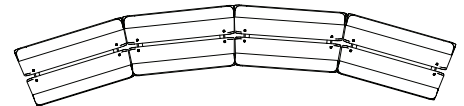
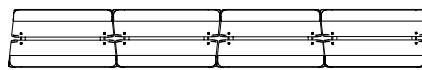

AVAILABLE COLOURS

Colors are subject to lead times and variations across batches

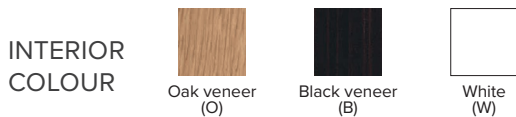

ACOUSTIC BASE AND BOARD COLOURS



Luxbox reserves the right to change the specification, material and colors at any time without notice. Standard warranty terms and conditions apply. All rights reserved © All dimensions and values on specification sheet are nominal. Thoughtboard's panels may change shape slightly over time, it is a natural movement due to changing temperature and humidity conditions. It will in no way affect performance or function. June, 2021. LX-Wedge-Thoughtboard-Acoustic-Spec-Sheet-v2.1



LUXBOX USA INC × (P)+1 (415) 871 0448 × USA@LUXBOX.COM
 LUXBOX PTY LTD × (P)+61 7 3257 2822 × INFO@LUXBOX.COM
 WWW.LUXBOX.COM





WEDGE THOUGHTBOARD ACOUSTIC (LX-WTA)

ACCESSORIES

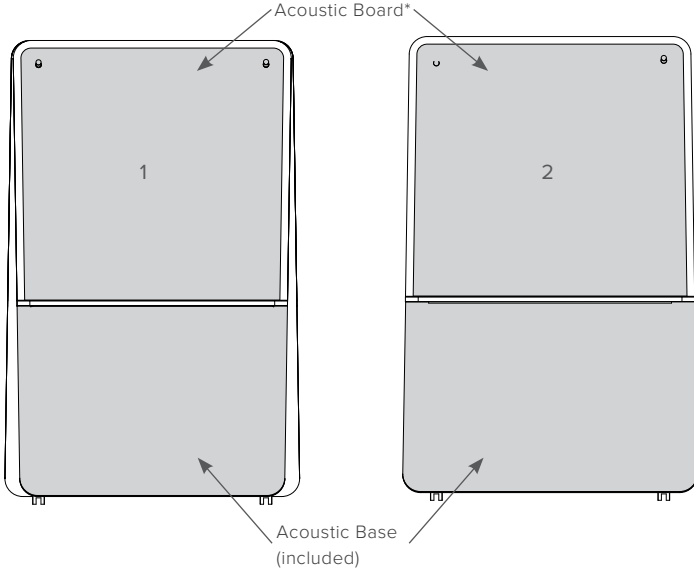

(1) ACOUSTIC BOARD SIDE A

(2) ACOUSTIC BOARD SIDE B

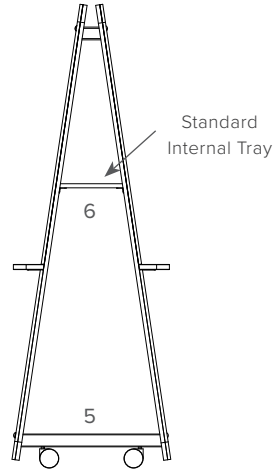

(3) FLIP CHART BRACKET

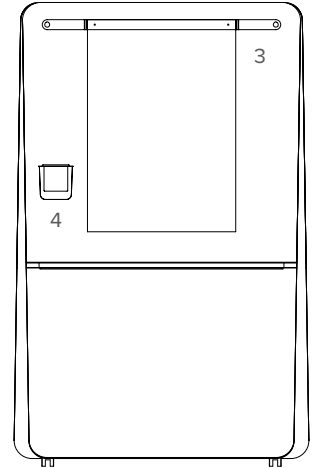

(4) PEN HOLDER

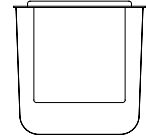
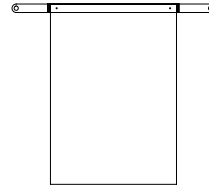
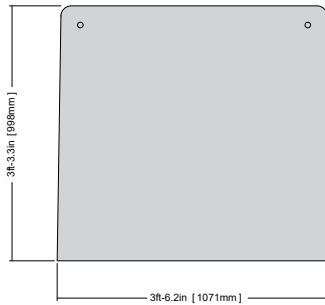
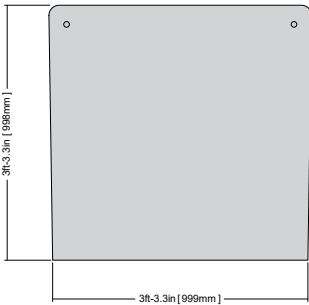

(6) INTERNAL TRAY

Standard (S)
(included by default)



Standard color: White



Premium (PT, PB)

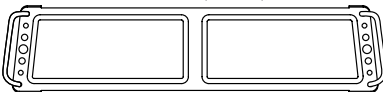

(5) BASE TRAY

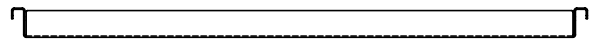

Standard color: Black

Luxxbox reserves the right to change the specification, material and colors at any time without notice. Standard warranty terms and conditions apply. All rights reserved © All dimensions and values on specification sheet are nominal. Thoughtboard's panels may change shape slightly over time, it is a natural movement due to changing temperature and humidity conditions. It will in no way affect performance or function. June, 2021. LX-Wedge-Thoughtboard-Acoustic-Spec-Sheet-v2.1



LUXXBOX USA INC × (P)+1 (415) 871 0448 × USA@LUXXBOX.COM
LUXXBOX PTY LTD × (P)+61 7 3257 2822 × INFO@LUXXBOX.COM
WWW.LUXXBOX.COM

