



WEDGE THOUGHTBOARD SLIM (LX-WTBS)

The narrow ThoughtBoard Slim is a quiet achiever with loud results. The narrow writing surface offers plenty of rooms for ideas, and a streak-free zero ghosting finish. A suite of magnetic accessories, including pen hold and pen shelf will help you organise your space in style. The ThoughtBoard Slim can also bring sound absorbency to any space with the addition of an acoustic pin board. High quality double castors enable easy movement on all surfaces, concealed for extra safety in open spaces.

KEY BENEFITS

- Superior quality ceramic steel writing surface
- Choice of laminate backing
- Use multiple ThoughtBoards to create a straight or curved room divider
- High quality lockable castors for ease of movement, concealed to remove trip hazard
- Ships flat, easy to assemble, short lead times
- Non-magnetic option available
- All versions include internal shelf
- Only GECA certified agile whiteboard on the market

SIZE

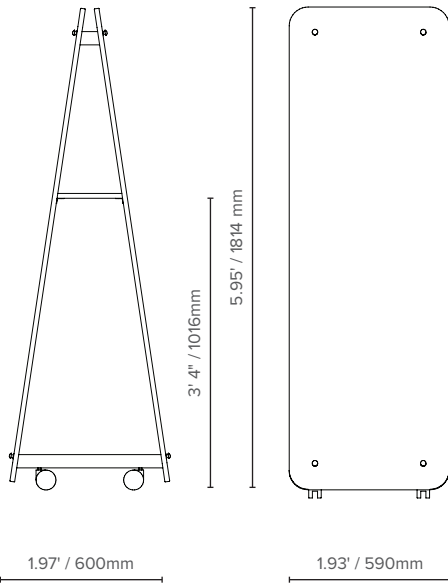

ORDER CODE

EXAMPLE: LX - WTBS - Y - W - W - S - 4, 5

(Luxxbox Wedge Thoughtboard Slim, Magnetic, White Interior, White Edges Pen Holder, Base Tray)

LX - WTBS	MAGNETIC		INTERIOR COLOR		EDGE COLOR		INTERNAL SHELF		OPTIONAL ACCESSORIES			
WTBS	Y	Yes	O	Oak Veneer	B	Black	S	Standard	1	Small Acoustic Board*	5	Base tray
	N***	No	B	Black Veneer	W	White	PT	Premium Timber	2	Large Acoustic Board*	6	External Shelf**
			W	White			PB	Premium Black	3	Flip Chart Bracket		
									4	Pen Holder**		

(*For Pin Board accessory option, please specify color code alongside (eg: 1LG, 2Y)
(**Pen Holder and External Shelf are only available for the Magnetic option)
(***)Warranty terms for non-magnetic option differs from magnetic)

Straight room divider

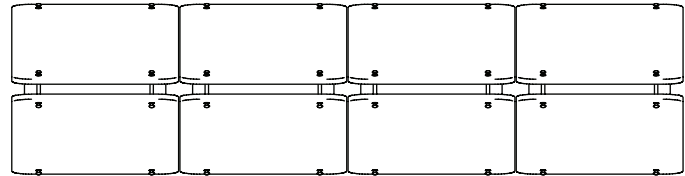

AVAILABLE COLORS

Colors are subject to lead times and variations across batches

INTERIOR COLOR

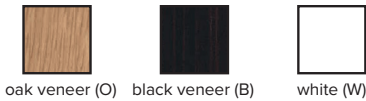

EDGE COLOR



PIN BOARD COLOR

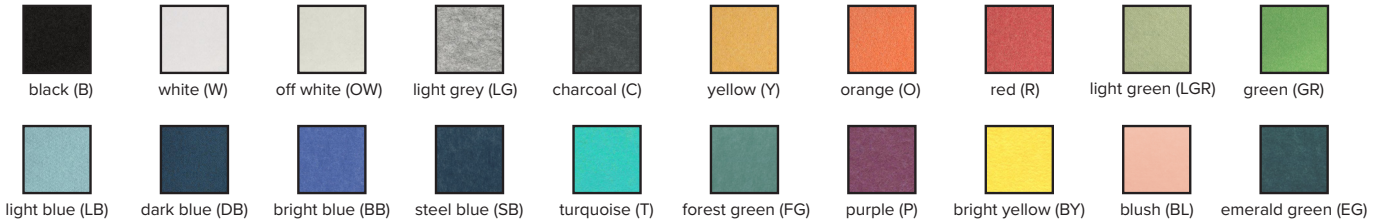

Luxxbox reserves the right to change the specification, material and colours at any time without notice. Standard warranty terms and conditions apply. All rights reserved. © Aug 2020 Ver 2.7
All dimensions and values on specification sheet are nominal. Thoughtboard's panels may change shape slightly over time, it is a natural movement due to changing temperature and humidity conditions. It will in no way affect performance or function.



WEDGE THOUGHTBOARD SLIM (LX-WTBS)

ACCESSORIES

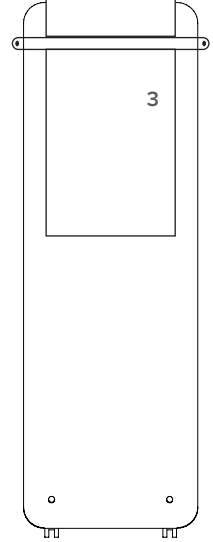
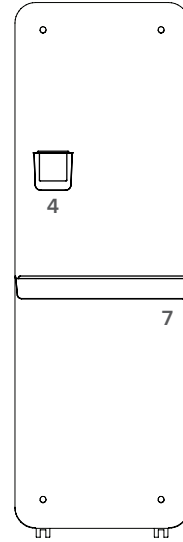
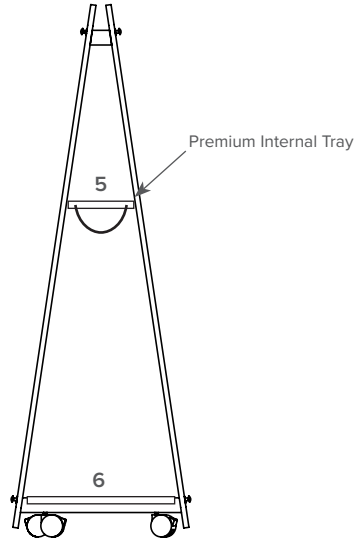
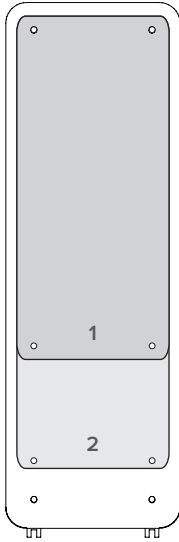

(1) SMALL PIN BOARD

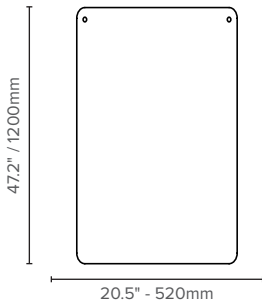

(2) LARGE PIN BOARD

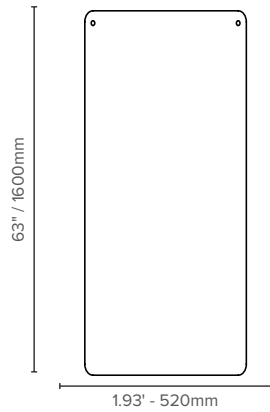

(3) FLIP CHART BRACKET

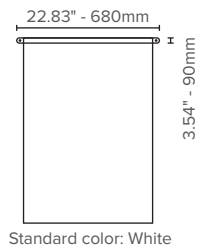

(4) PEN HOLDER

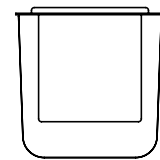

Standard color: White
(only available for magnetic option)

INTERNAL TRAY

Standard (S)
(included by default)



Standard color: White



Premium (PT, PB)

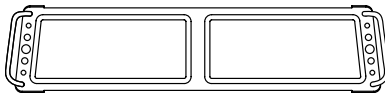

(final design in development)



(5) BASE TRAY



Standard color: Black

(6) EXTERNAL SHELF

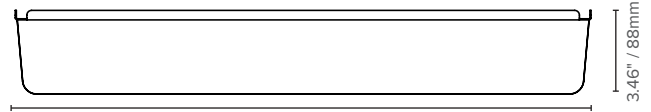

Standard color: White
(only available for the magnetic option)

Luxxbox reserves the right to change the specification, material and colours at any time without notice. Standard warranty terms and conditions apply. All rights reserved. © Aug 2020 Ver 4.7
All dimensions and values on specification sheet are nominal. Thoughtboard's panels may change shape slightly over time, it is a natural movement due to changing temperature and humidity conditions. It will in no way affect performance or function.



LUXXBOX USA INC × (P)+1 (415) 871 0448 × USA@LUXXBOX.COM
LUXXBOX PTY LTD × (P)+61 7 3257 2822 × INFO@LUXXBOX.COM
WWW.LUXXBOX.COM

