

WEDGE THOUGHTBOARD (LX-WTB)

Wedge ThoughtBoard forms part of Luxxbox's Agile Board range. The elegant ThoughtBoard is a quiet achiever with loud results. The whiteboard surface serves many purposes, helping you to organise your life or office in style. With the addition of the sound absorbency panel, the ThoughtBoard can also help hush open-plan spaces, creating a little slice of calm. High quality double castors enable easy movement on all flooring surfaces.

KEY BENEFITS

- Superior quality ceramic steel writing surface
- Choice of laminate backing
- Use multiple ThoughtBoards to create a straight or curved room divider
- High quality lockable castors for ease of movement, concealed to remove trip hazard
- Ships flat, easy to assemble, short lead times
- Non-magnetic option available
- All versions include internal shelf
- Only GECA certified agile whiteboard on the market

SIZE

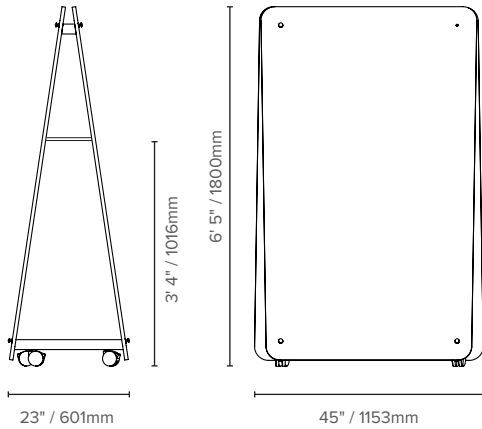

ORDER CODE

EXAMPLE: LX - WTB - Y - W - B - S - 1LG - 4

(Luxxbox Wedge ThoughtBoard, Magnetic, White, Black, Standard internal shelf, Small Pin Board-Light Grey, Pen Holder)

LX - WTB	MAGNETIC		INTERIOR COLOR		EDGE COLOR		INTERNAL SHELF		OPTIONAL ACCESSORIES	
PRODUCT CODE	Y	No***	O	B	B	W	S	PT	1	5
WTB	Yes		Oak Veneer	Black Veneer	Black	White	Standard	Premium Timber	Small Acoustic Board*	Base Tray
			White				Premium Black	Large Acoustic Board*	External Shelf**	
								Pen Holder**		

(*For Pin Board accessory option, please specify color code alongside (eg: 1LG, 2Y)
(**Pen Holder and External Shelf are only available for the Magnetic option)
(***)Warranty terms for non-magnetic option differs from magnetic)

Straight room divider

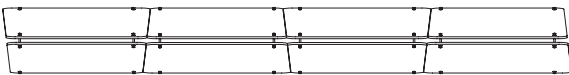

Curved room divider

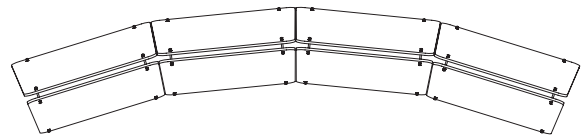

AVAILABLE COLORS

Colors are subject to lead times and variations across batches

INTERIOR COLOR

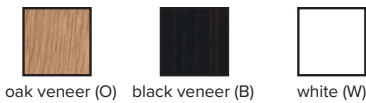

EDGE COLOR

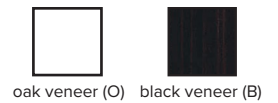

ACOUSTIC BOARD COLOR

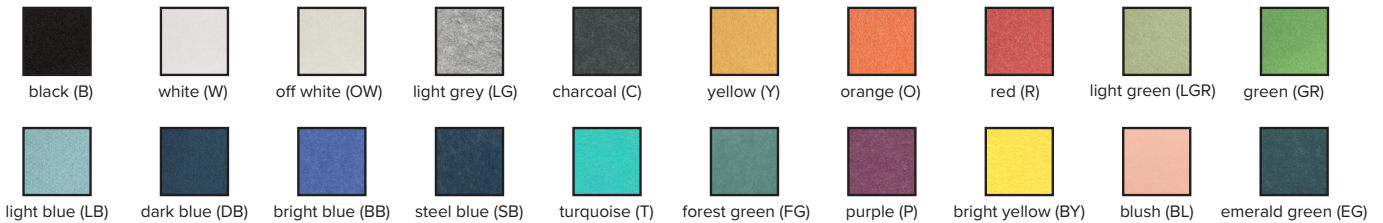

Luxxbox reserves the right to change the specification, material and colours at any time without notice. Standard warranty terms and conditions apply. All rights reserved. © Aug 2020 Ver 4.7
All dimensions and values on specification sheet are nominal. Thoughtboard's panels may change shape slightly over time, it is a natural movement due to changing temperature and humidity conditions. It will in no way affect performance or function.



LUXXBOX USA INC × (P)+1 (415) 871 0448 × USA@LUXXBOX.COM
LUXXBOX PTY LTD × (P)+61 7 3257 2822 × INFO@LUXXBOX.COM
WWW.LUXXBOX.COM





WEDGE THOUGHTBOARD (LX-WTB)

ACCESSORIES

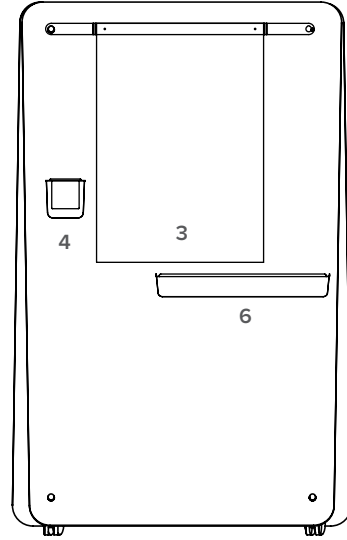
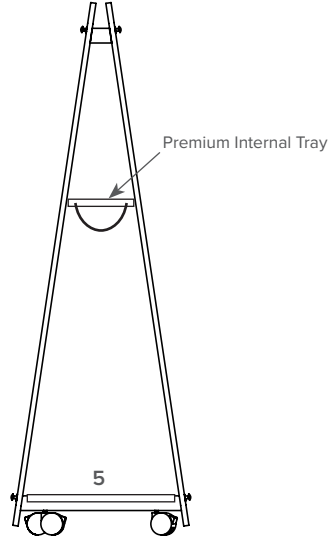
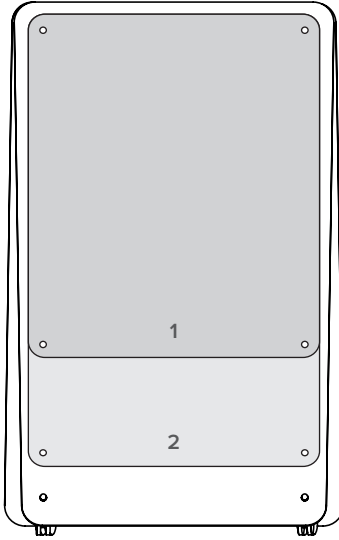

(1) SMALL ACOUSTIC BOARD

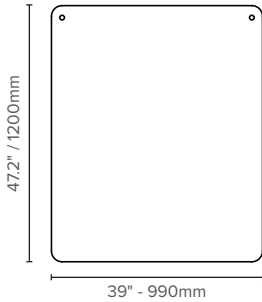

(2) LARGE ACOUSTIC BOARD

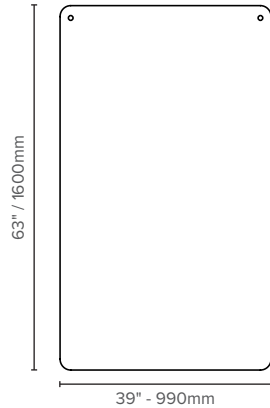

(3) FLIP CHART BRACKET

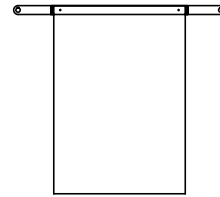

Standard color: White

(4) PEN HOLDER

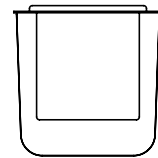

Standard color: White
(only available for the magnetic option)

INTERNAL TRAY

Standard (S)
(included by default)



Standard color: White



Premium (PT, PB)

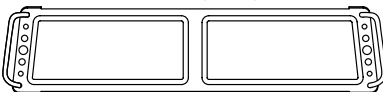

(5) BASE TRAY



Standard color: Black

(6) EXTERNAL SHELF

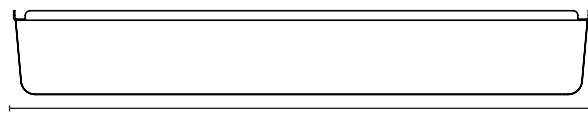

22.83" - 580mm

Standard color: White

(only available for the magnetic option)

Luxxbox reserves the right to change the specification, material and colours at any time without notice. Standard warranty terms and conditions apply. All rights reserved. © Aug 2020 Ver 4.7
All dimensions and values on specification sheet are nominal. Thoughtboard's panels may change shape slightly over time, it is a natural movement due to changing temperature and humidity conditions. It will in no way affect performance or function.



LUXXBOX USA INC × (P)+1 (415) 871 0448 × USA@LUXXBOX.COM
LUXXBOX PTY LTD × (P)+61 7 3257 2822 × INFO@LUXXBOX.COM
WWW.LUXXBOX.COM

