

TYPE:

Short in stature, but not in style, Luxxbox's Dasch pendant light combines a sleek curve and subtle diffusion of light to create a striking luminaire. Available in four standard lengths, Dasch is a perfect fit for corridors and hallways. Or make full use of the void between desk and ceiling pane with lights that act as a means of sound management.

KEY BENEFITS

- Highly effective noise absorption
- Available in 4 lengths and a wide range of colors
- Customizable shade and end cap colors
- High performance dimmable LED light source
- Height adjustable 9' / 3m suspension cables per fixture
- 9' / 3m length of black woven power cable per fixture
- Casambi bluetooth available
- POE available on request
- IES photometric files available
- Bluetooth controller available upon request
- Available in the MOTIF collection



MOTIF

SIZE, OUTPUT AND WEIGHT

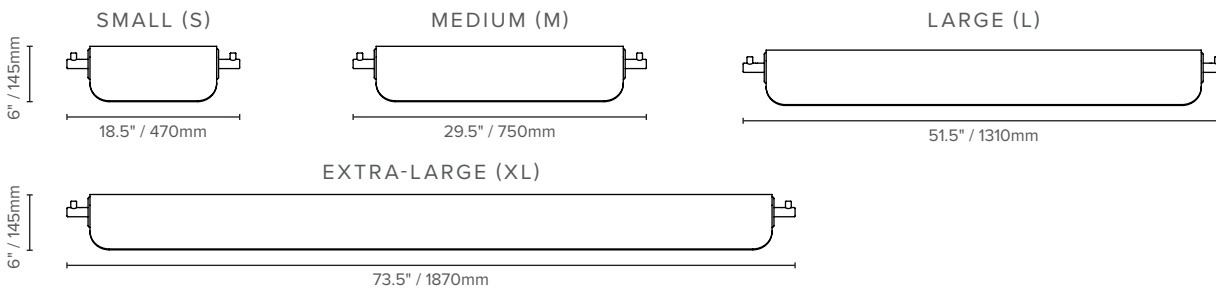

	SMALL			MEDIUM			LARGE			EXTRA LARGE		
	Delivered Lumens	Wattage	Efficacy lm/W	Delivered Lumens	Wattage	Efficacy lm/W	Delivered Lumens	Wattage	Efficacy lm/W	Delivered Lumens	Wattage	Efficacy lm/W
Direct Output	209	15	14	469	24	20	964	50	19	1540	73	21
Weight	13.2 lbs / 6 Kg			17.6 lbs / 8 Kg			22 lbs / 10 Kg			30.9 lbs / 14 Kg		

ORDER CODE

EXAMPLE: LX - DA - L - DB - SL - 40 - UNV - RD

(Luxxbox Dasch, Large (52" / 1310mm), Dark Blue shade, Silver Anodized end caps, 4000K, Universal 110-277V / 0-10V dimming, Remote driver)

LX - DA	SIZE		SHADE COLOR	END CAP FINISH	COLOR TEMP		REGION / DIMMING		DRIVER TYPE	
DA	S	18.5" / 470mm	Use color codes as shown	Use color codes as shown	30	3000K	UNV	Universal 110-277VAC / 0 - 10V 10% dimming (North America only) Global 220 - 240V 1% dimming DSI / DALI	RD	Remote driver
	M	29.5" / 750mm			35	3500K			CD	Canopy concealed driver
	L	52" / 1310mm			40	4000K				
	XL	73.5" / 1870mm								

AVAILABLE COLORS

Colors are subject to lead times and variations across batches

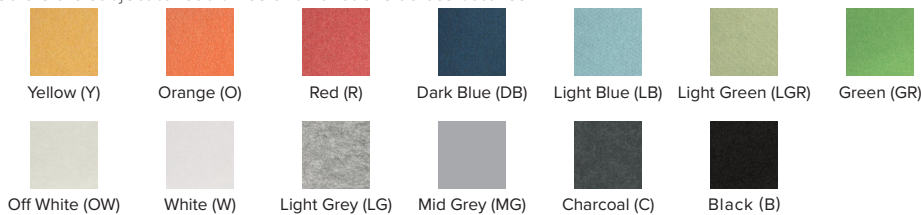

END CAP FINISH

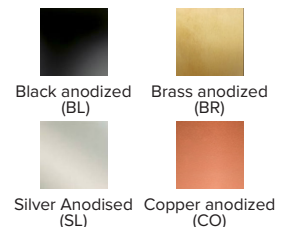

Luxxbox reserves the right to change the specification, material and colors at any time without notice. Standard warranty terms and conditions apply. All rights reserved © All dimensions and values on specification sheet are nominal. Color and pattern are for illustrative purposes only. Variation in pattern and alignment may occur from product to product. December 2020. LX-Dasch-Spec Sheet-2020-v3.8



LUXXBOX USA INC × (P)+1 (415) 871 0448 × USA@LUXXBOX.COM
 LUXXBOX PTY LTD × (P)+61 7 3257 2822 × INFO@LUXXBOX.COM
 WWW.LUXXBOX.COM





DASCH (LX-DA)

TYPE:

PHOTOMETRICS

SMALL (18.5" / 470mm)	
Delivered Lumen Output	209lm
Wattage	14W
Efficacy	19 lumens per watt
CRI	90
CCT	3000, 3500, 4000 K

MEDIUM (29.5" / 750mm)	
Delivered Lumen Output	469lm
Wattage	22W
Efficacy	19 lumens per watt
CRI	90
CCT	3000, 3500, 4000 K

LARGE (52" / 1310mm)	
Delivered Lumen Output	964lm
Wattage	44W
Efficacy	19 lumens per watt
CRI	90
CCT	3000, 3500, 4000 K

EXTRA LARGE (74" / 1870mm)	
Delivered Lumen Output	1540lm
Wattage	65W
Efficacy	19 lumens per watt
CRI	90
CCT	3000, 3500, 4000 K

LUMINOUS INTENSITY DISTRIBUTION

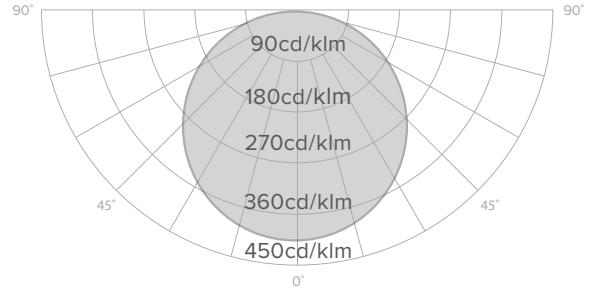

DRIVER INFORMATION

Meanwell - 10% DIMMING				
Size	Driver Code	Watts	Output	Compliance
SMALL (18.5" / 470mm)	Meanwell HLG-40H-24B	40W	24VDC	
MEDIUM (29.5" / 750mm)	Meanwell HLG-40H-24B	40W	24VDC	
LARGE (52" / 1310mm)	Meanwell HLG-60H-24B	60W	24VDC	
EXTRA LARGE (74" / 1870mm)	Meanwell HLG-80H-24B	80W	24VDC	

Tridonic - 1% DIMMING				
Size	Driver Code	Watts	Output	Compliance
SMALL (18.5" / 470mm)	Tridonic LCA 35W 24V ONE4ALL SC PRE	35W	24VDC	
MEDIUM (29.5" / 750mm)	Tridonic LCA 35W 24V ONE4ALL SC PRE	35W	24VDC	
LARGE (52" / 1310mm)	Tridonic LCA 60W 24V one4all SC PRE	60W	24VDC	
EXTRA LARGE (74" / 1870mm)	Tridonic LCA 100W 24V one4all SC PRE	100W	24VDC	

CANOPY INFORMATION

Please note power cord and canopy will always be supplied in black unless specified otherwise.

SIZE	NORTH AMERICA		GLOBAL	
	DRIVER OPTION	DRIVER OPTION	DRIVER OPTION	DRIVER OPTION
	RD	CD	RD	CD
DA-S	SA	CD13	SB	CD13
DA-M	SA	CD13	SB	CD13
DA-L	SA	CD13	SB	CD13
DA-XL	SA	CD13	SB	CD13

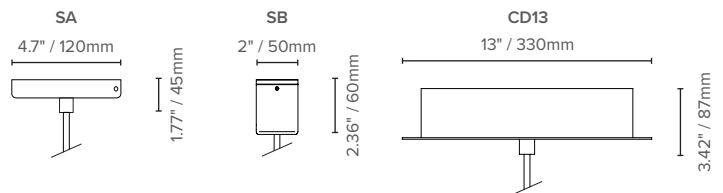

Luxxbox reserves the right to change the specification, material and colors at any time without notice. Standard warranty terms and conditions apply. All rights reserved © All dimensions and values on specification sheet are nominal. Color and pattern are for illustrative purposes only. Variation in pattern and alignment may occur from product to product. December 2020. LX-Dasch-Spec Sheet-2020-v3.8



LUXXBOX USA INC × (P)+1 (415) 871 0448 × USA@LUXXBOX.COM
 LUXXBOX PTY LTD × (P)+61 7 3257 2822 × INFO@LUXXBOX.COM
 WWW.LUXXBOX.COM





DASCH (LX-DA)

TYPE:

MATERIAL SPECIFICATIONS

	COLOR CODES: C, LG, MG	COLOR CODES: B, W, OW, DB, LB, G, LG, R, O, Y
COLOR FASTNESS TO LIGHT:	ISO 105-B02-1994 Rating: 6-7	ISO 105-B02-1994 Rating: 6-7
FIRE TEST:	AS 1530.3 ISO 9705: Group 1 BS 476: Part 7 Class 2	AS ISO 9705 - 2003: Group 1 ISO 9705 - 1993: Group 1s ASTM E-84-14 (A, FS:0 - SD:45) BS EN13501-1:2007+A1:2009 (B-s1, d0)
ENVIRONMENTAL:	PET achieves GreenTag Certification GreenRate: Level A	PET achieves GreenTag Certification GreenRate: Level A
THERMAL TRANSITION:	ASTM C518-2010. R- Value = 0.30 m ² K/W	ASTM C518-2010. R- Value = 0.30 m ² K/W
SOUND ABSORPTION:	AS ISO 354 – 2006 Noise reduction coefficient (NRC) = 0.45	AS ISO 354 – 2006 Noise reduction coefficient (NRC) = 0.45
VOC EMISSIONS:	ASTM D5116 Rate: < 0.02 mg/m ² /hr (7 days)	ASTM D5116 Rate: < 0.01 mg/m ² /hr (7 days)

PET ACOUSTIC PROPERTIES

Products are given a Noise Reduction Coefficient (NRC) from 0 to 1 based on their ability to absorb sound, where 1.0 equals 100% sound absorption. The NRC is used to calculate Sabin value of any surface material. The Sabin value equals the NRC multiplied by the total surface area in squared feet or squared metres.

(S) 18.5" / 470MM	(M) 29.5" / 750mm	(L) 52" / 1310mm	(XL) 74" / 1870mm
0.34 Sabins (imperial) 0.03 Sabins (metric)	0.61 Sabins (imperial) 0.06 Sabins (metric)	1.2 Sabins (imperial) 0.1 Sabins (metric)	1.7 Sabins (imperial) 0.16 Sabins (metric)

ACOUSTIC PROPERTIES

Visualization of decibel decay across the Dasch range. Effects of a 0.45 NRC across a range of frequencies.

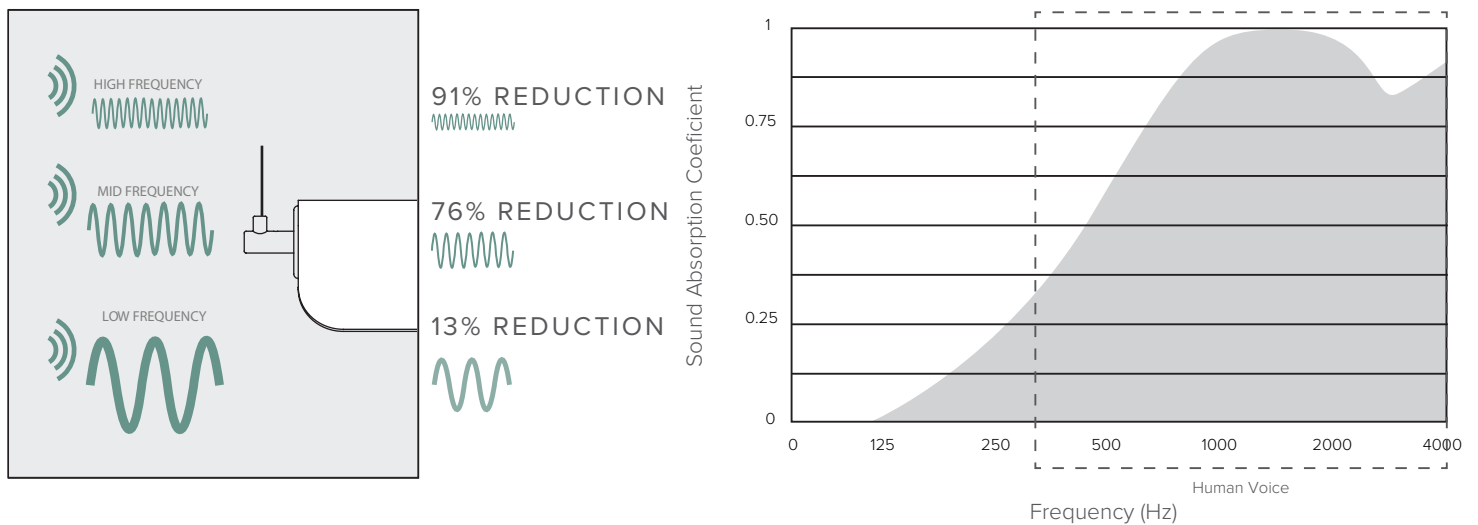

Luxxbox reserves the right to change the specification, material and colors at any time without notice. Standard warranty terms and conditions apply. All rights reserved © All dimensions and values on specification sheet are nominal. Color and pattern are for illustrative purposes only. Variation in pattern and alignment may occur from product to product. December 2020. LX-Dasch-Spec Sheet-2020-v3.8



LUXXBOX USA INC × (P)+1 (415) 871 0448 × USA@LUXXBOX.COM
LUXXBOX PTY LTD × (P)+61 7 3257 2822 × INFO@LUXXBOX.COM
WWW.LUXXBOX.COM





DASCH (LX-DA)

TYPE:

PRODUCT DIMENSIONS

SIDE VIEWS

SMALL

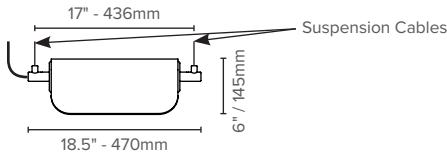

END VIEW

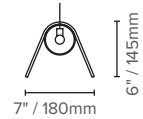

MEDIUM

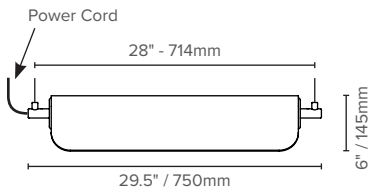

LARGE

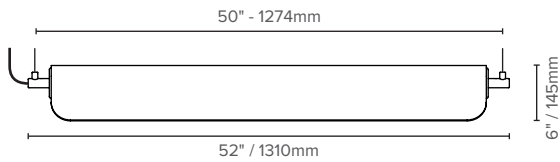

EXTRA-LARGE

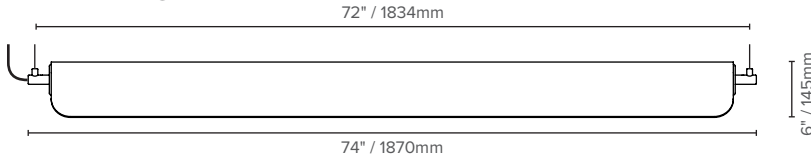

EXAMPLE: SUSPENSION - POWER

On the side views above you can see the power cord will always exit the pendant through the side of the pendant, very close to the suspension cable.

At the moment we don't supply canopies with suspension points, so our recommended method of installation is shown on the diagram on the right.

You will find more detailed information about the canopy on page 3 of this document or on the Installation Instructions document on our website.

Recommended Installation

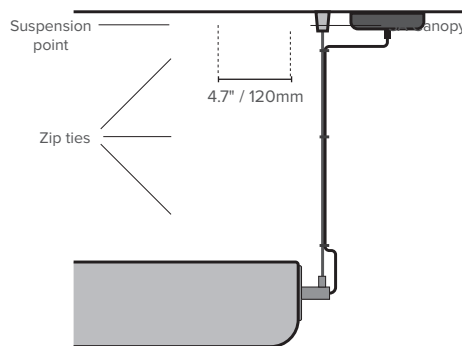

Luxxbox reserves the right to change the specification, material and colors at any time without notice. Standard warranty terms and conditions apply. All rights reserved © All dimensions and values on specification sheet are nominal. Color and pattern are for illustrative purposes only. Variation in pattern and alignment may occur from product to product. December 2020. LX-Dasch-Spec Sheet-2020-v3.8



LUXXBOX USA INC × (P)+1 (415) 871 0448 × USA@LUXXBOX.COM
 LUXXBOX PTY LTD × (P)+61 7 3257 2822 × INFO@LUXXBOX.COM
 WWW.LUXXBOX.COM

