

LINEA

TESSELL (LX-TE)

TYPE:

KEY FEATURES

- Part of the Linea family's innovative acoustic baffle and linear lighting system
- Highly effective noise absorption
- 2 sizes, 3 heights and 70+ finishes
- High performance dimmable LED light sources - direct and/or indirect wash
- Multiple shielding options available
- UGR <5 on direct louvered output
- Cassette style driver for easy servicing
- Height adjustable 9' / 3m suspension cables and Black woven power cable
- IES photometric files available
- Also available as acoustic baffle only

OPTIONAL EXTRAS

- Additional options available upon request
- POE
 - Casambi Bluetooth (US only)
 - Tunable White output
 - White canopy and power cord
 - Custom sizes
 - Additional color options
 - Can be integrated with Linea fixtures

SIZE AND OUTPUT

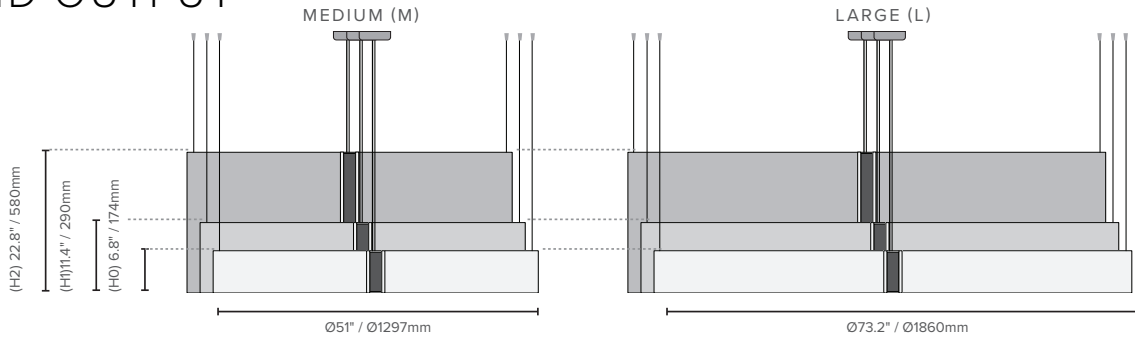

	DA		DB		DC		I		DIA		DIB		DIC	
Beam Angle (Direct Indirect)	50° (direct)		76° (direct)		100° (direct)		160° (indirect)		50° (direct) - 160° (indirect)		76° (direct) - 160° (indirect)		100° (direct) - 160° (indirect)	
Shielding (down up)	Louvered (direct)		Louvered (direct)		Diffused (direct)		Lensed (indirect)		Louvered (direct) Lensed (indirect)		Louvered (direct) Lensed (indirect)		Diffused (direct) Lensed (indirect)	
UGR (Direct)	<5		<5		-		-		<5		<5		-	
CCT CRI	CCT: 3000K/3500K/4000K CRI >90													
Medium: Lumens (direct indirect)	6360	0	6186	0	4872	0	0	5790	6360	5790	6186	5790	4872	5790
Medium: Wattage	48W		48W		78W		48W		96W		96W		126W	
Large: Lumens (direct indirect)	9540	0	9279	0	7308	0	0	8685	9540	8685	9279	8685	7308	8685
Large: Wattage	72W		72W		117W		72W		144W		144W		189W	
Efficacy (lm/W)	133		129		67		121		127		125		89	

ORDER CODE

EXAMPLE: LX - TE - M - H2 - B - R - 40 - DIA - U1 - CD

(Luxxbox Linea Tessell, Medium (51"/1297mm), Height 2 (22.8"/580mm), Basica, Red color, 4000K CCT, Direct A + Indirect output, 0-10V 1% dimming 110-277VAC, Canopy concealed driver)

LX - TE		SIZE		HEIGHT		PATTERN		COLOR*		COLOR TEMP		OUTPUT***		REGION / DIMMING		DRIVER TYPE	
TE	M	Medium	H0	6.8"/174mm	B	Basica	Use color code as shown on pg. 2	30	3000K	DA	Direct A (50°, Louvered)	UNV	0-10V - 1% dimming (110 - 277VAC) (North America only)	CD	Canopy concealed driver (UNV / North America only)		
		51"/1297mm	H1	11.4"/290mm	R	Ranura		35	3500K	DB	Direct B (76°, Louvered)						
	L	Large	H2	22.8"/580mm			40	4000K	DC	Direct C (100°, Diffused)	G****	0-10V - 1% dimming DSI / DALI (220 - 240V)	RD	Remote Driver (UNV or G)			
		73.2"/1860mm				A**	Acoustic only	I	Indirect (160°, Lensed)	DIA					DA (direct) + I (indirect)	DIB	DB (direct) + I (indirect)

*Core always in Charcoal | **For acoustic baffle only, specify A in the 'color temp' column and leave the remaining columns blank
 See pg.3 for more information about the different Output options | * Global (G) dimming type is available with Remote driver (RD) only

Luxxbox reserves the right to change the specification, material and colors at any time without notice. Standard warranty terms and conditions apply. All rights reserved © All dimensions and values on specification sheet are nominal. Linea Tessell product code LX-LN-TE. February, 2024. LX-Tessell-Spec-SheetLV2 v4.5



LUXXBOX USA INC × (P)+1 (415) 871 0448 × USA@LUXXBOX.COM
 LUXXBOX PTY LTD × (P)+61 7 3257 2822 × INFO@LUXXBOX.COM
 WWW.LUXXBOX.COM





LINEA

TESSELL (LX-TE)

TYPE:

SHIELDING OPTIONS

DIRECT

Louvered (DA/DB)

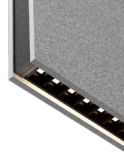

DIRECT

Diffused (DIC)

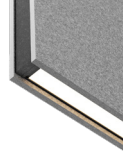

INDIRECT

Lensed (I/DIA/DIB/DIC)

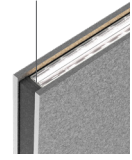

DIRECT/INDIRECT

Acoustic Baffle (A)

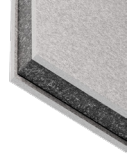

PATTERN OPTIONS

Basica (B)

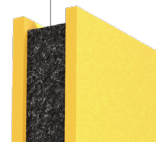

Ranura (R)

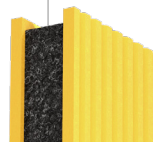

AVAILABLE COLORS & PATTERNS

Colors are subject to lead times and variations across batches

SOLID PET COLOR OPTIONS

CORE



DESIGNER



CLASSIC WOOL COLOR OPTIONS

Only available for 'Basica' option



Luxxbox reserves the right to change the specification, material and colors at any time without notice. Standard warranty terms and conditions apply. All rights reserved © All dimensions and values on specification sheet are nominal. Linea Tessell product code LX-LN-TE. February, 2024. LX-Tessell-Spec-SheetV2 v4.5



LUXXBOX USA INC × (P)+1 (415) 871 0448 × USA@LUXXBOX.COM
 LUXXBOX PTY LTD × (P)+61 7 3257 2822 × INFO@LUXXBOX.COM
 WWW.LUXXBOX.COM





LINEA

TESSELL (LX-TE)

TYPE:

PHOTOMETRICS

IES files can easily be downloaded from our website

	DA		DB		DC		I		DIA		DIB		DIC	
Beam Angle (Direct Indirect)	50° (direct)		76° (direct)		100° (direct)		160° (indirect)		50° (direct) + 160° (indirect)		76° (direct) + 160° (indirect)		100° (direct) + 160° (indirect)	
Shielding (down up)	Louvered (direct)		Louvered (direct)		Diffused (direct)		Lensed (indirect)		Louvered (direct) Lensed (indirect)		Louvered (direct) Lensed (indirect)		Diffused (direct) Lensed (indirect)	
UGR (Direct)	<5		<5		-		-		<5		<5		-	
CCT CRI	CCT: 3000K/3500K/4000K CRI >90													
Medium: Lumens (direct indirect)	6360	0	6186	0	4872	0	0	5790	6360	5790	6186	5790	4872	5790
Medium: Wattage	48W		48W		78W		48W		96W		96W		126W	
Large: Lumens (direct indirect)	9540	0	9279	0	7308	0	0	8685	9540	8685	9279	8685	7308	8685
Large: Wattage	72W		72W		117W		72W		144W		144W		189W	
Efficacy (lm/W)	133		129		67		121		127		125		89	

LIGHT DISTRIBUTION

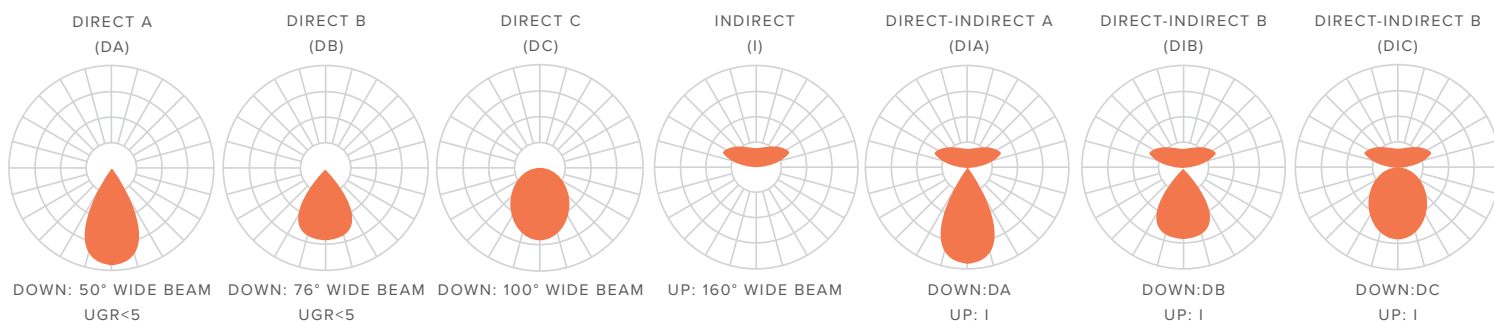

TM-30METRICS

Fidelity Index (Rf): Average similarity to the reference source for all colors

Gamut Index (Rg): Average change in chroma for all colors

	MEDIUM/LARGE
Rf (Fidelity Index)	83
Rg (Gamut Index)	96

COLOR VECTOR GRAPHIC MEDIUM/LARGE

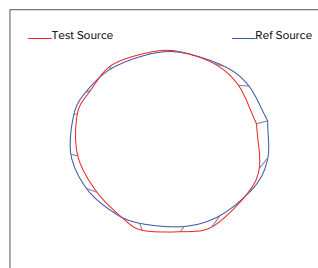

Luxbox reserves the right to change the specification, material and colors at any time without notice. Standard warranty terms and conditions apply. All rights reserved © All dimensions and values on specification sheet are nominal. Linea Tessell product code LX-LN-TE. February, 2024. LX-Tessell-Spec-Sheet.V2 v4.5



LUXBOX USA INC × (P)+1 (415) 871 0448 × USA@LUXBOX.COM
 LUXBOX PTY LTD × (P)+61 7 3257 2822 × INFO@LUXBOX.COM
 WWW.LUXBOX.COM





LINEA

TESSELL (LX-TE)

TYPE:

DRIVER INFORMATION

CODE	REGION/DIMMING	SIZE	DA / DB / DC / I		DIA / DIB / DIC		COMPLIANCE
			Max Wattage	Max Output	Max Wattage	Max Output	
UNV	UNIVERSAL 0-10V - 1% dimming 110 - 277VAC <i>(North America only)</i>	LX-TE-M	90W	2-55V	225W	2-55V	
		LX-TE-L					
G	GLOBAL 0-10V - 1% dimming 220 - 240VAC	LX-TE-M	111W	15-54V	111W	15-54V	
		LX-TE-L			240W	20-54V	

CANOPY INFORMATION

Please note power cord and canopy will always be supplied in black unless specified otherwise.

PRODUCT	SIZE	OUTPUT	UNIVERSAL (UNV)		GLOBAL (G)
			CD	RD	RD
LX-TE	ALL SIZES	D	CD9R	SA5	SB1

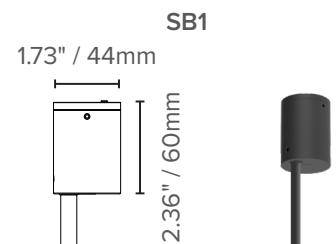
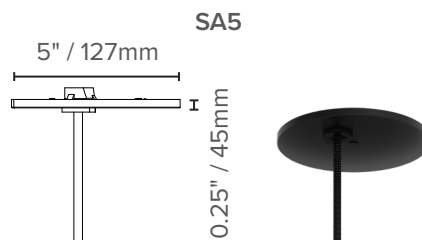
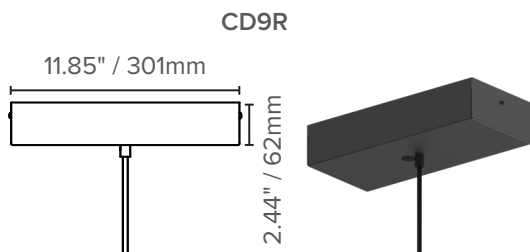

Luxbox reserves the right to change the specification, material and colors at any time without notice. Standard warranty terms and conditions apply. All rights reserved © All dimensions and values on specification sheet are nominal. Linea Tessell product code LX-LN-TE. February, 2024. LX-Tessell-Spec-Sheet.V2 v4.5



LUXBOX USA INC × (P)+1 (415) 871 0448 × USA@LUXBOX.COM
 LUXBOX PTY LTD × (P)+61 7 3257 2822 × INFO@LUXBOX.COM
 WWW.LUXBOX.COM





TYPE:

MATERIAL SPECIFICATIONS

COLOR FASTNESS TO LIGHT:	ISO 105-B02-1994 Rating: 6-7
FIRE TEST:	AS 1530.3 / ISO 9705: Group 1 / GB8624 B1 / ASTM E-84-14 (Class A, FSI:20 - SDI:450) / BS EN13501-1:2007+A1:2009 (B-s1, d0)
ENVIRONMENTAL:	PET achieves GreenTag Certification / GreenRate: Level A
THERMAL TRANSITION:	ASTM C518-2010. R- Value = 0.30 m ² K/W
SOUND ABSORPTION:	AS ISO 354 – 2006 / Noise reduction coefficient (NRC) = 0.85
VOC EMISSIONS:	ASTM D5116 Rate: < 0.01 mg/m ² /hr (7 days)

Please note some of these certificates will apply to specific colors.

PRODUCT ACOUSTIC PROPERTIES

Testing and post analysis procedures were carried out in accordance with the references detailed below:

AS ISO 354-2006 (R2016)	Acoustics—Measurement of sound absorption in a reverberation room
AS ISO 11654—2002	Rating of sound absorption—Materials and systems
ASTM C423-17	Standard Test Method for Sound Absorption and Sound Absorption Coefficients by the Reverberation Room Method
ASTM E795-16	Standard Practices for Mounting Test Specimens During Sound Absorption Tests
ISO 20189	Screens, furniture and single objects intended for interior use – Rating of sound absorption and sound reduction of elements based on laboratory measurements.

IMPERIAL SABINS	MEDIUM			LARGE		
Frequency (Hz)	H0	H1	H2	H0	H1	H2
125	0.68	1.14	2.27	1.01	1.68	3.35
250	1.47	2.44	4.89	2.16	3.61	7.21
500	2.21	3.68	7.36	3.26	5.43	10.86
1000	2.64	4.40	8.79	3.89	6.49	12.98
2000	2.91	4.84	9.69	4.29	7.15	14.29
4000	3.10	5.16	10.32	4.57	7.61	15.23

METRIC SABINS	MEDIUM			LARGE		
Frequency (Hz)	H0	H1	H2	H0	H1	H2
125	0.13	0.21	0.42	0.19	0.31	0.62
250	0.27	0.45	0.91	0.40	0.67	1.34
500	0.41	0.68	1.37	0.61	1.01	2.02
1000	0.49	0.82	1.63	0.72	1.21	2.41
2000	0.54	0.90	1.80	0.80	1.33	2.66
4000	0.58	0.96	1.92	0.85	1.41	2.83

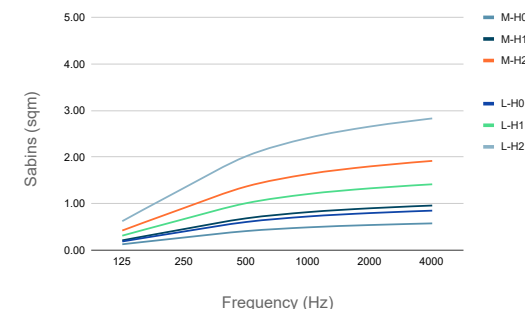
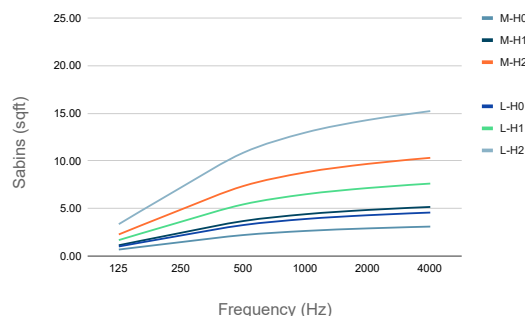

The Sabin data shown above is in accordance with the latest International Standards for the rating of sound absorption and reduction. This is different from the classic methodology, which includes the calculation of the Noise Reduction Coefficient (NRC), the Sound Absorption Average (SAA), the Weighted Sound Absorption Coefficient (**aw**) and the Sound Absorption Class (SAC). However, to make it easier to compare against other products, we are including that information on the table on the right, which was calculated using the Horizontal Floor Area method. Fully detailed test reports are available upon request.

NRC	1.95
SAA	1.93
aw	1.00
SAC	A

Luxbox reserves the right to change the specification, material and colors at any time without notice. Standard warranty terms and conditions apply. All rights reserved © All dimensions and values on specification sheet are nominal. Linea Tessell product code LX-LN-TE. February, 2024. LX-Tessell-Spec-SheetV2 v4.5



LUXBOX USA INC × (P)+1 (415) 871 0448 × USA@LUXBOX.COM
 LUXBOX PTY LTD × (P)+61 7 3257 2822 × INFO@LUXBOX.COM
 WWW.LUXBOX.COM





LINEA

TESSELL (LX-TE)

TYPE:

PRODUCT DIMENSIONS

MEDIUM (M)

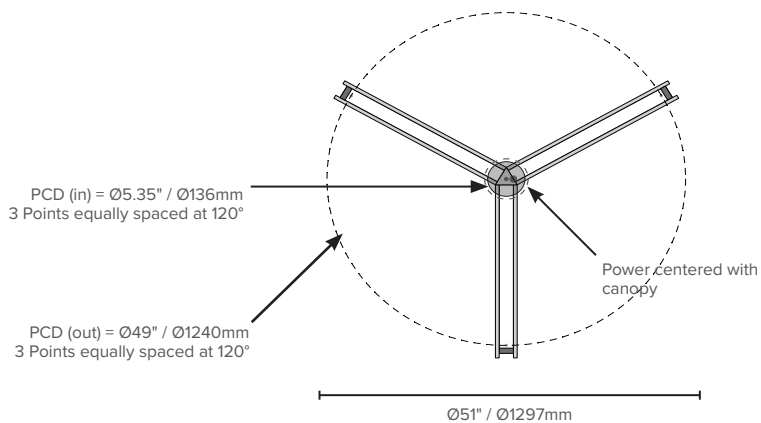

LARGE (L)

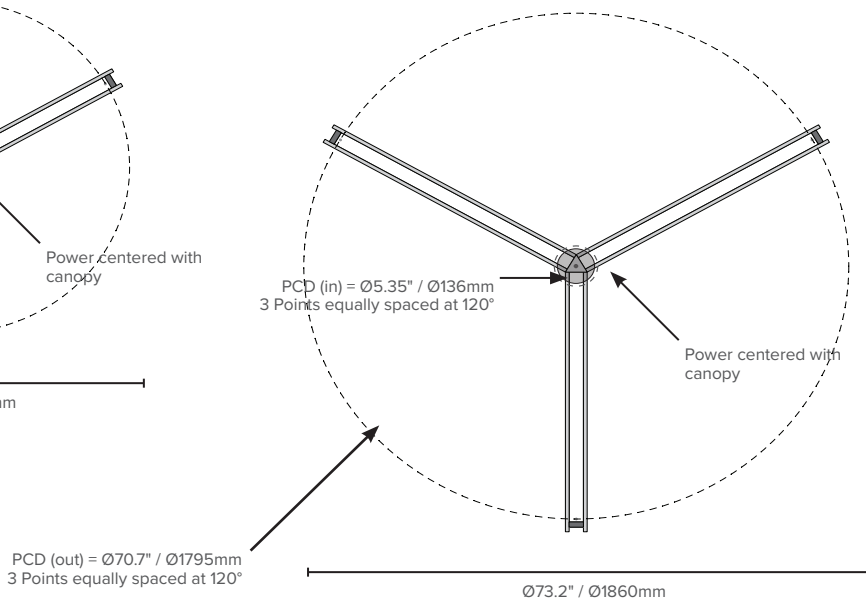

MEDIUM (M)

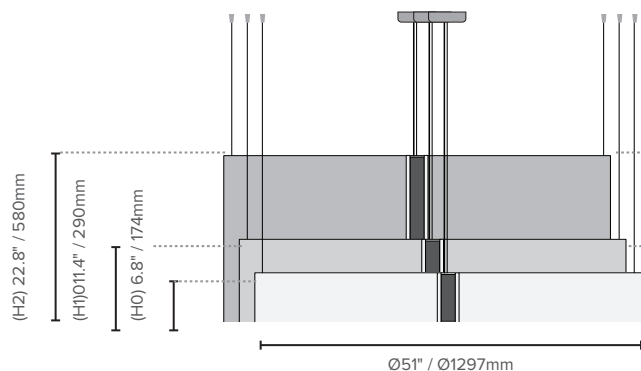

LARGE (L)

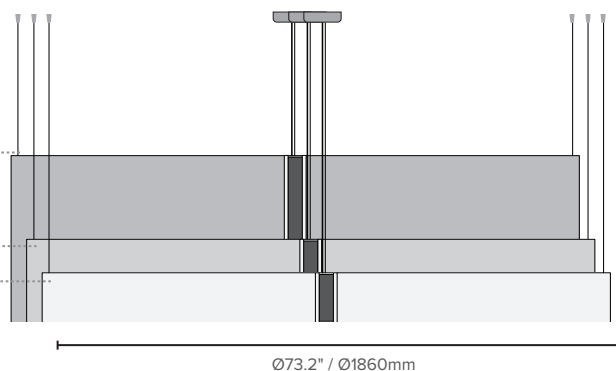

Luxxbox reserves the right to change the specification, material and colors at any time without notice. Standard warranty terms and conditions apply. All rights reserved © All dimensions and values on specification sheet are nominal. Linea Tessel product code LX-LN-TE. February, 2024. LX-Tessel-Spec-SheetV2 v4.5



LUXXBOX USA INC × (P)+1 (415) 871 0448 × USA@LUXXBOX.COM
 LUXXBOX PTY LTD × (P)+61 7 3257 2822 × INFO@LUXXBOX.COM
 WWW.LUXXBOX.COM





LINEA

TESSELL (LX-TE)

TYPE:

LAYOUT EXAMPLES

STANDARD MEETING TABLES

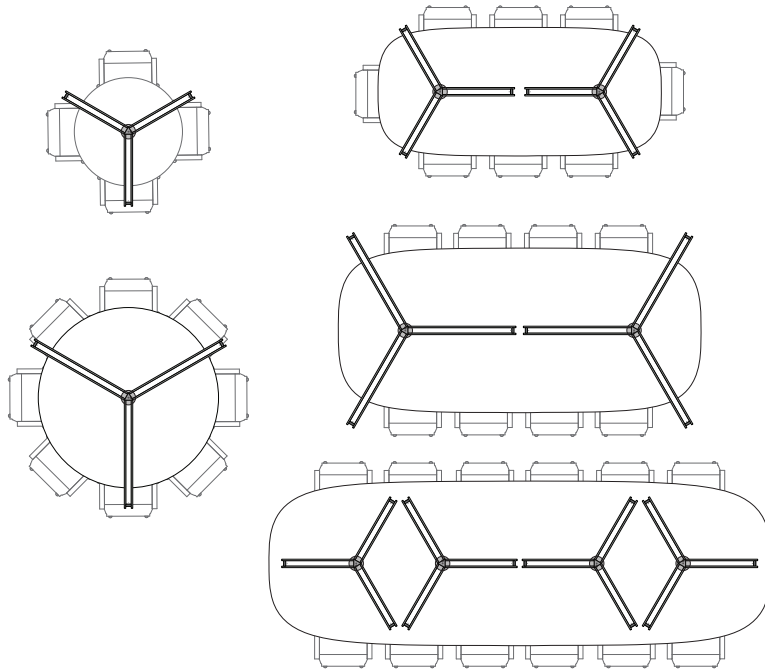

LINEAR LAYOUTS

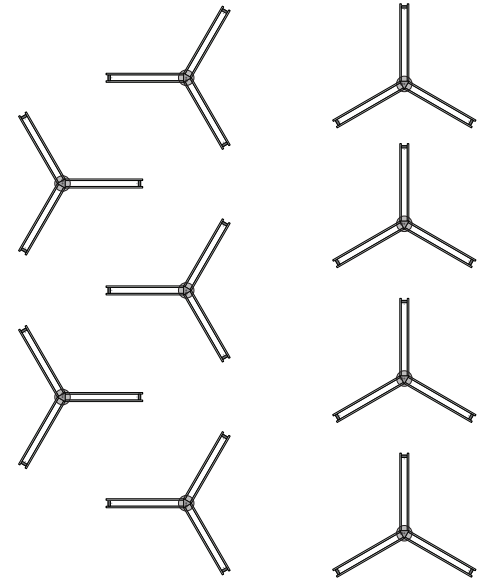

COLLABORATIVE SPACES

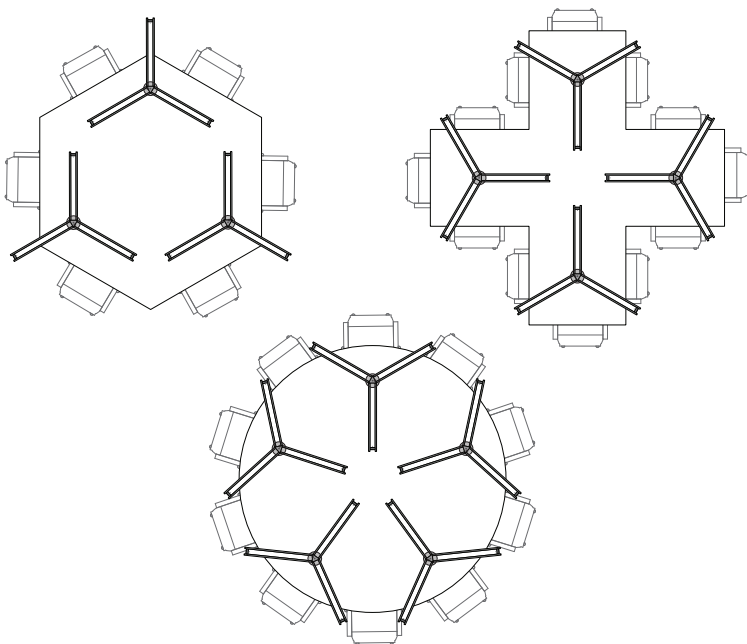

LARGE AREAS

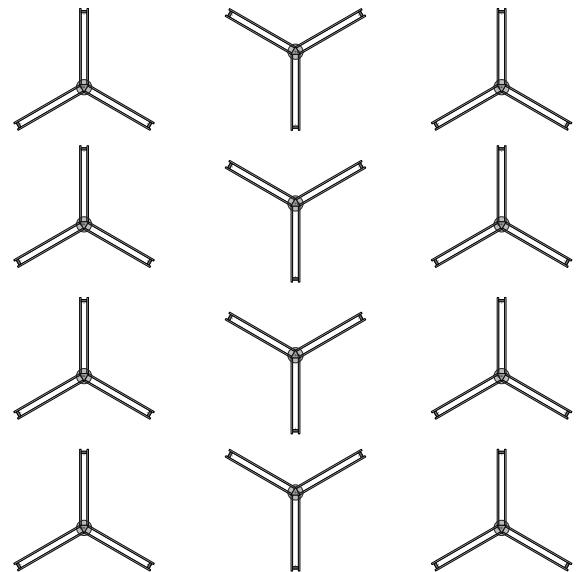

Luxbox reserves the right to change the specification, material and colors at any time without notice. Standard warranty terms and conditions apply. All rights reserved © All dimensions and values on specification sheet are nominal. Linea Tessel product code LX-LN-TE. February, 2024. LX-Tessel-Spec-SheetV2 v4.5



LUXBOX USA INC × (P)+1 (415) 871 0448 × USA@LUXBOX.COM
LUXBOX PTY LTD × (P)+61 7 3257 2822 × INFO@LUXBOX.COM
WWW.LUXBOX.COM

