



ILLI BON (LX-IB)

TYPE:

KEY FEATURES

- High-performance lumen output
- UGR<19
- Highly effective noise absorption
- 2 sizes and a wide range of colors
- Remote Driver only
- 9' / 2.740mm length of black woven power cable per fixture
- IES photometric files available
- Some assembly required

OPTIONAL EXTRAS

- Additional options available upon request:
- POE
 - Bluetooth controller (US & EU only)
 - Tunable White output
 - White canopy and power cord

SIZE, OUTPUT AND WEIGHT

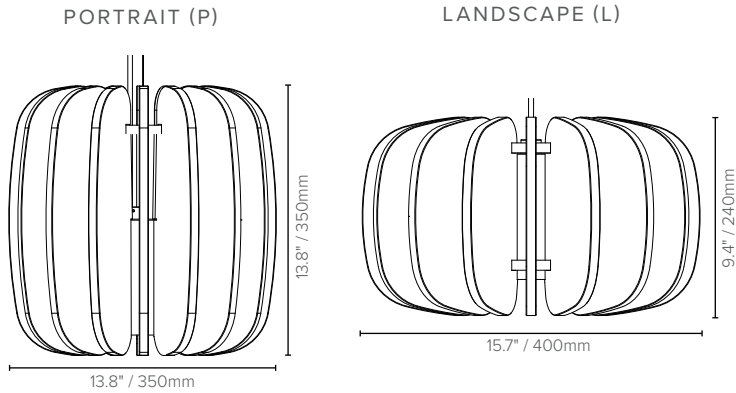

LUMINOUS INTENSITY DISTRIBUTION

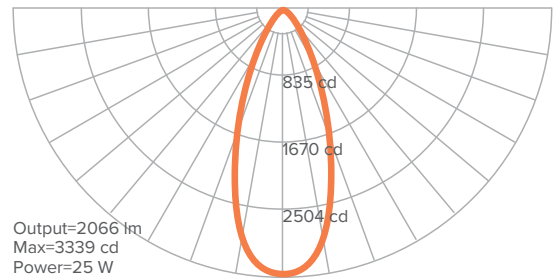

LANDSCAPE AND PORTRAIT	
Delivered Lumen Output	2066lm
Wattage	25W
Efficacy	83 lm/W
CRI	90+
UGR	<19
Beam Angle	45°
CCT	3000/3500/4000 K
Weight	Landscape 5.3 lbs / 2.4 Kg Portrait 5.7 lbs / 2.6 Kg

ORDER CODE

EXAMPLE: LX - IB - L - R - 40 - UNV

(Luxxbox illi Bon, Landscape (15.7"x9.4" / 400x240mm), Red, 4000K, Universal 110-277V / 0-10V 10% dimming (North America only))

LX - IB							
PRODUCT CODE	SIZE	SHADE COLOR	COLOR TEMP		REGION / DIMMING		
IB	L	LANDSCAPE (15.7"x9.4" / 400x240mm)	Use color codes as shown	30	3000K	UNV	Universal 110 - 277V / 0-10V 10% Dimming (North America only)
	P			35	3500K		
				40	4000K	G	Global 220-240V 1% dimming DSI/DALI

Please note this fixture has a Remote Driver and doesn't allow for On-Board or Canopy Concealed Driver options

AVAILABLE COLORS

Colors are subject to lead times and variations across batches

CORE

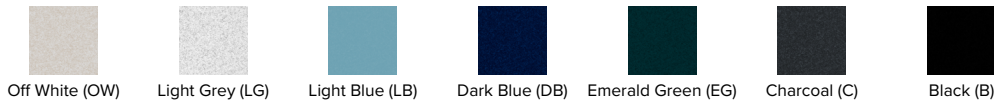

DESIGNER



Luxxbox reserves the right to change the specification, material and colors at any time without notice. Standard warranty terms and conditions apply. All rights reserved © All dimensions and values on specification sheet are nominal. March 2024. LX-IlliBon-Spec-Sheet v1.0



LUXXBOX USA INC × (P)+1 (415) 871 0448 × USA@LUXXBOX.COM
LUXXBOX PTY LTD × (P)+61 7 3257 2822 × INFO@LUXXBOX.COM
WWW.LUXXBOX.COM



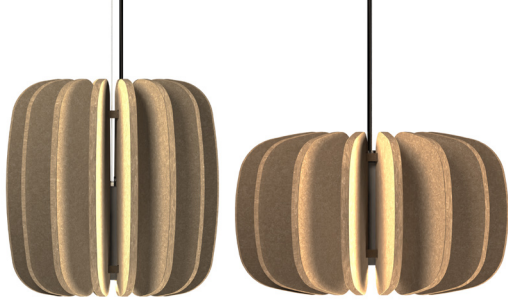

ILLI BON (LX-IB)

TYPE:

PHOTOMETRICS

LIGHT SOURCE SPECIFICATIONS

	LANDSCAPE AND PORTRAIT
Delivered Lumen Output	2066lm
Wattage	25W
Efficacy	83 lm/W
CRI	90+
UGR	<19
Beam Angle	45°
CCT	3000/3500/4000 K
Weight	Landscape 5.3 lbs / 2.4 Kg Portrait 5.7 lbs / 2.6 Kg

LUMINOUS INTENSITY DISTRIBUTION

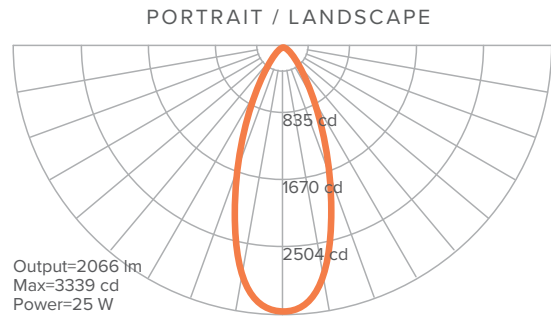

DRIVER INFORMATION

REGION/DIMMING	SIZE	WATTAGE (W)	MAX VOLTAGE (V)	COMPLIANCE
UNIVERSAL (UNV) 0-10V - 10% dimming 110 - 277VAC <i>(North America only)</i>	PORTRAIT	25 W	28-42VDC	
	LANDSCAPE			
GLOBAL (G) 0-10V - 1% dimming 220 - 240VAC DSI DALI	PORTRAIT	25 W	28-42VDC	
	LANDSCAPE			

CANOPY INFORMATION

Please note power cord and canopy will always be supplied in black unless specified otherwise.

	UNV (North America)	G
PORTRAIT	SA4	SB4
LANDSCAPE	SA4	SB4



Luxxbox reserves the right to change the specification, material and colors at any time without notice. Standard warranty terms and conditions apply. All rights reserved © All dimensions and values on specification sheet are nominal. March 2024. LX-IlliBon-Spec-Sheet v1.0



LUXXBOX USA INC × (P)+1 (415) 871 0448 × USA@LUXXBOX.COM
 LUXXBOX PTY LTD × (P)+61 7 3257 2822 × INFO@LUXXBOX.COM
 WWW.LUXXBOX.COM



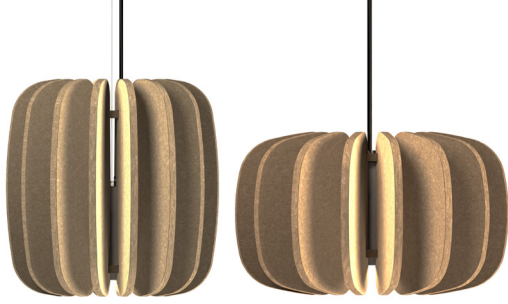

ILLI BON (LX-IB)

TYPE:

MATERIAL SPECIFICATIONS

COLOR FASTNESS TO LIGHT:	ISO 105-B02-1994 Rating: 6-7
FIRE TEST:	AS 1530.3 / ISO 9705: Group 1 / GB8624 B1 / ASTM E-84-14 (Class A, FSI:20 - SDI:450) / BS EN13501-1:2007+A1:2009 (B-s1, d0)
ENVIRONMENTAL:	PET achieves GreenTag Certification / GreenRate: Level A
THERMAL TRANSITION:	ASTM C518-2010. R- Value = 0.30 m ² K/W
SOUND ABSORPTION:	AS ISO 354 – 2006 / Noise reduction coefficient (NRC) = 0.85
VOC EMISSIONS:	ASTM D5116 Rate: < 0.01 mg/m ³ /hr (7 days)

Please note some of these certificates will apply to specific colors.

PRODUCT ACOUSTIC PROPERTIES

Testing and post analysis procedures were carried out in accordance with the references detailed below:

AS ISO 354-2006 (R2016)	Acoustics—Measurement of sound absorption in a reverberation room
AS ISO 11654—2002	Rating of sound absorption—Materials and systems
ASTM C423-17	Standard Test Method for Sound Absorption and Sound Absorption Coefficients by the Reverberation Room Method
ASTM E795-16	Standard Practices for Mounting Test Specimens During Sound Absorption Tests
ISO 20189	Screens, furniture and single objects intended for interior use – Rating of sound absorption and sound reduction of elements based on laboratory measurements.

IMPERIAL SABINS

Frequency (Hz)	Sound Absorption Coefficient	PORTRAIT (P)	LANDSCAPE (L)
125	0.06	0.86	0.99
250	0.33	4.71	5.45
500	0.73	10.42	12.05
1000	1	14.27	16.51
2000	0.96	13.70	15.85
4000	1	14.27	16.51

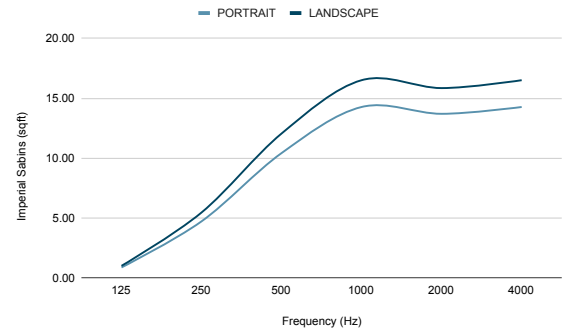

METRIC SABINS

Frequency (Hz)	Sound Absorption Coefficient	PORTRAIT (P)	LANDSCAPE (L)
125	0.06	0.08	0.09
250	0.33	0.44	0.50
500	0.73	0.97	1.12
1000	1	1.33	1.53
2000	0.96	1.28	1.47
4000	1	1.33	1.53

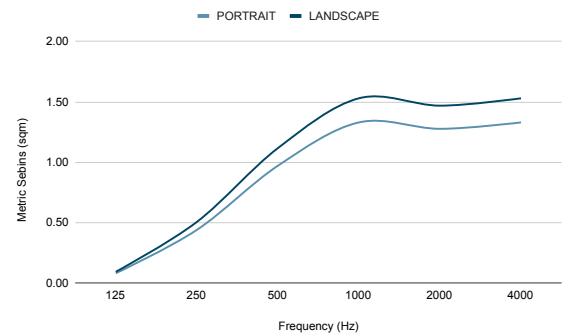

The Sabin data shown above is in accordance with the latest International Standards for the rating of sound absorption and reduction. This is different from the classic methodology, which includes the calculation of the Noise Reduction Coefficient (NRC), the Sound Absorption Average (SAA), the Weighted Sound Absorption Coefficient (**aw**) and the Sound Absorption Class (SAC). However, to make it easier to compare against other products, we are including that information on the table on the right, which was calculated using the Horizontal Floor Area method. Fully detailed test reports are available upon request.

NRC	0.75
SAA	0.75
aw	0.6
SAC	D

Luxxbox reserves the right to change the specification, material and colors at any time without notice. Standard warranty terms and conditions apply. All rights reserved © All dimensions and values on specification sheet are nominal. March 2024. LX-IIIIBon-Spec-Sheet v1.0



LUXXBOX USA INC × (P)+1 (415) 871 0448 × USA@LUXXBOX.COM
 LUXXBOX PTY LTD × (P)+61 7 3257 2822 × INFO@LUXXBOX.COM
 WWW.LUXXBOX.COM



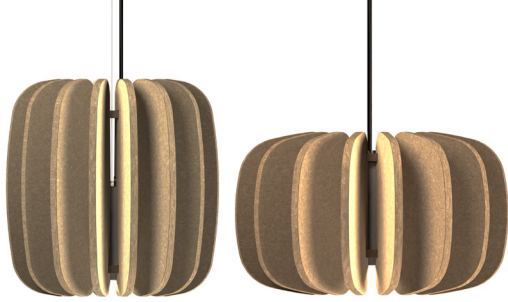

ILLI BON (LX-IB)

TYPE:

PRODUCT DIMENSIONS

Please note the dimensions shown below refer to the assembled product. This pendant will be shipped flat pack and requires assembly. For more information, download the Assembly and Installation Instructions document from the product's page at www.luxxbox.com

LANDSCAPE (L)

PORTRAIT (P)

BOTTOM

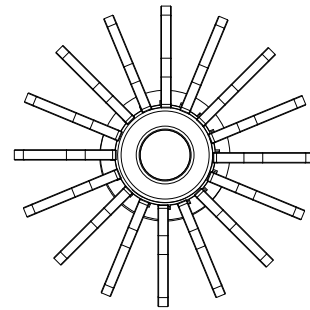
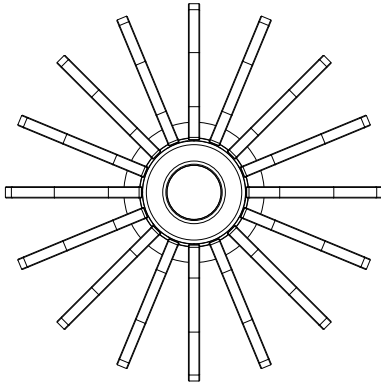

FRONT

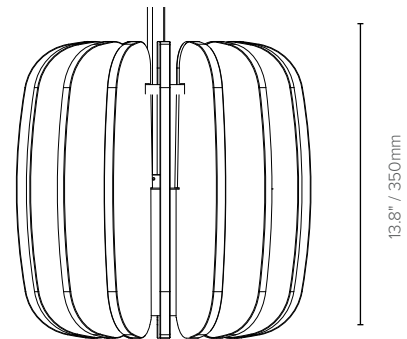
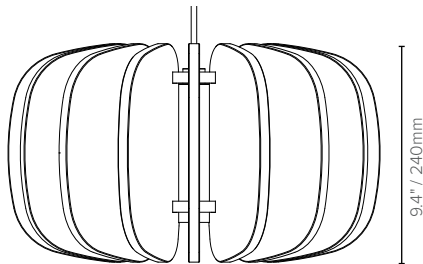

TOP

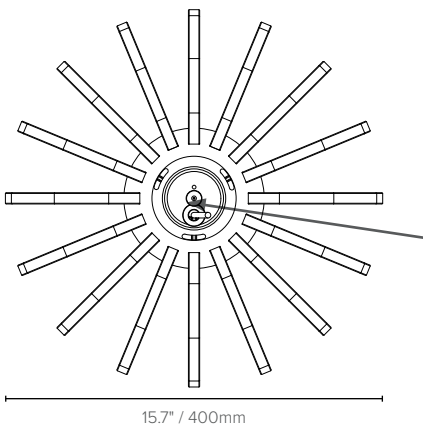

Suspension
(centered with pendant
and canopy)

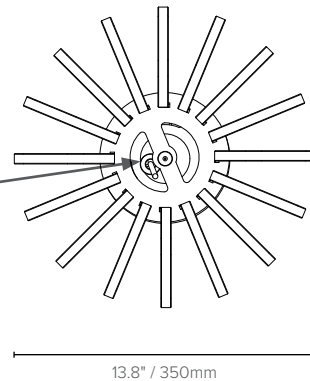

Luxxbox reserves the right to change the specification, material and colors at any time without notice. Standard warranty terms and conditions apply. All rights reserved © All dimensions and values on specification sheet are nominal. March 2024. LX-IlliBon-Spec-Sheet v1.0



LUXXBOX USA INC × (P)+1 (415) 871 0448 × USA@LUXXBOX.COM
LUXXBOX PTY LTD × (P)+61 7 3257 2822 × INFO@LUXXBOX.COM
WWW.LUXXBOX.COM

