

TYPE:

KEY FEATURES

- Highly effective noise absorption
- 3 sizes and a wide range of colors
- High performance dimmable LED light source (Direct)
- Optional upwards wash dimmable LED lighting (Indirect)
- UGR<19
- Height adjustable 9' / 3m suspension cables and Black woven power cable
- IES photometric files available
- L70 lifetime rating of 50,000 hours
- Can be mounted flush to ceiling

OPTIONAL EXTRAS

Additional options available upon request

- 0.1% dimming option
- POE
- Bluetooth controller (US & EU only)
- Tunable White output
- White canopy and power cord

SIZE, OUTPUT AND WEIGHT

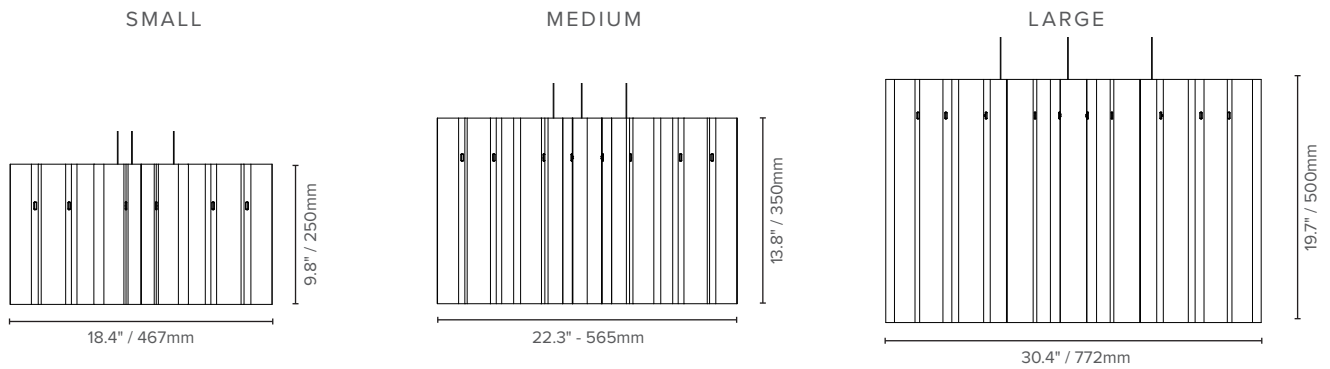

	SMALL			MEDIUM			LARGE		
Output	Lumens	Wattage	Efficacy	Lumens	Wattage	Efficacy	Lumens	Wattage	Efficacy
Direct	1634 lm	24 W	68 lm/W	3476 lm	41.9 W	82.9 lm/W	3850 lm	48 W	80 lm/W
Weight	13.2 lbs / 6 Kg			17.6 lbs / 8 Kg			22 lbs / 10 Kg		

ORDER CODE

EXAMPLE FOR STANDARD LED PANEL: LX - KU - L - DB - 40 - UNV - RD

(Luxxbox Kurtain, Large - dia 30.4" x 19.7" / dia 772 x 500 mm, Dark Blue, 4000K, Universal 120-277V / 0-10V 1% dimming, Remote driver)

EXAMPLE FOR E26/E27 LAMP HOLDER: LX - KU - M - OW - E26

(Luxxbox Kurtain, Medium - dia 22.3" x 13.8" / dia 565 x 350 mm, Off White, E26 lamp holder (120V AC))

LX - KU		SIZE	*SHADE COLOR	COLOR TEMP		DRIVER / DIMMING		DRIVER TYPE	
KU	S	Small 18.4" x 9.8" / 467 x 250 mm	Use color codes as shown	30	3000K	UNV	0 - 10V - 1% dimming (120-277V) (North America only)	CD	Canopy concealed driver (UNV/North America only)
	M	Medium 22.3" x 13.8" / 565 x 350 mm		35	3500K				
	L	Large 30.4" x 19.7" / 772 x 500 mm		40	4000K	G***	1% dimming DSI/DALI (220 - 240V)	RD	Remote driver (UNV or G)
				*E26	E26 Lamp holder - 120V AC (North America only)				
				*E27	E27 Lamp holder - 220-240V AC (Global)				

* Please note the light globe or driver will not be supplied with the E26/E27 option for this fixture. | **Direct + Indirect or Indirect output is not currently available for the Small size
*** Global (G) dimming type is available with Remote driver (RD) only



KURTAIN (LX-KU)

TYPE:

WOOL UPHOLSTERED

For any of the options below, the interior will always be in Felt Gray. See comparison between Wool Upholstered and Felt Finish at the bottom of the page for reference.



Luxxbox reserves the right to change the specification, material and colors at any time without notice. Standard warranty terms and conditions apply. All rights reserved © All dimensions and values on specification sheet are nominal. April 2024. LX-Kurtain-Spec Sheet V1.2



LUXXBOX USA INC × (P)+1 (415) 871 0448 × USA@LUXXBOX.COM
LUXXBOX PTY LTD × (P)+61 7 3257 2822 × INFO@LUXXBOX.COM
WWW.LUXXBOX.COM



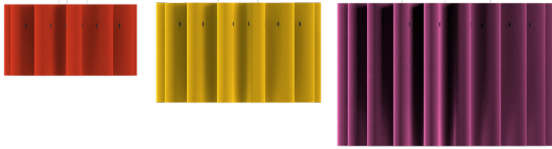

KURTAIN (LX-KU)

TYPE:

PHOTOMETRICS

	SMALL	MEDIUM	LARGE
	Direct	Direct	Direct
Delivered Lumes Output	1634 lm	3476 lm	3850 lm
Wattage	24 W	41.9 W	48 W
Efficacy	68 lm/W	82.9 lm/W	80 lm/W
CRI	90+		
CCT	3000, 3500, 4000 K		
UGR	<19		

LUMINOUS INTENSITY DISTRIBUTION

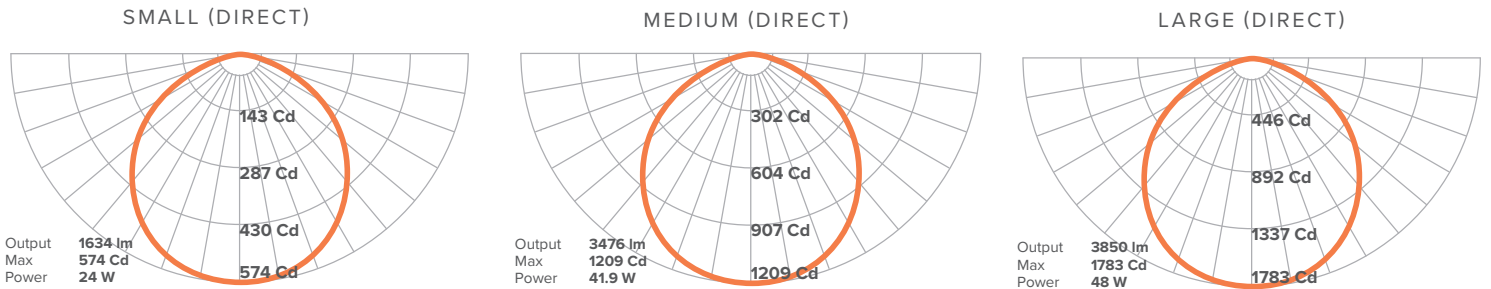

TM-30METRICS

Fidelity Index (Rf): Average similarity to the reference source for all colors
 Gamut Index (Rg): Average change in chroma for all colors

	SMALL AND MEDIUM	LARGE
Fidelity Index (Rf)	90	90.7
Gamut Index (Rg)	100	98.8

COLOR VECTOR GRAPHIC

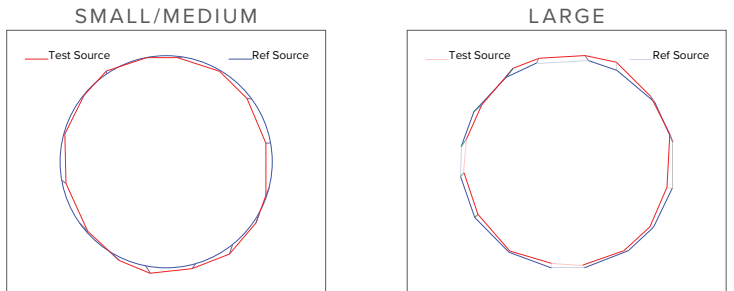

Luxbox reserves the right to change the specification, material and colors at any time without notice. Standard warranty terms and conditions apply. All rights reserved © All dimensions and values on specification sheet are nominal. April 2024. LX-Kurtain-Spec Sheet V1.2



LUXBOX USA INC × (P)+1 (415) 871 0448 × USA@LUXBOX.COM
 LUXBOX PTY LTD × (P)+61 7 3257 2822 × INFO@LUXBOX.COM
 WWW.LUXBOX.COM





KURTAIN (LX-KU)

TYPE:

DRIVER INFORMATION

REGION/DIMMING	SIZE	WATTAGE (W)	MAX VOLTAGE (V)	COMPLIANCE
		Direct (D)		
UNIVERSAL (UNV) 0-10V - 1% dimming 110 - 277VAC <i>(North America only)</i>	SMALL	24 W	10-55VDC	
	MEDIUM	41.9 W		
	LARGE	48 W		
GLOBAL (G) 0-10V - 1% dimming 220 - 240VAC DSI DALI	SMALL	24 W	6-52VDC	
	MEDIUM	41.9 W		
	LARGE	45.6 W		

CANOPY INFORMATION

Please note power cord and canopy will always be supplied in black unless specified otherwise.

PRODUCT	SIZE	OUTPUT	UNIVERSAL (UNV)			GLOBAL (G)	
			CD	RD	E26	RD	E27
LX-BC	SMALL	D / DI	CD5	SA5	SA5	SB1	SB1
	MEDIUM	D / DI	CD5	SA5	SA5	SB1	SB1
	LARGE	D / DI	CD5	SA5	SA5	SB1	SB1

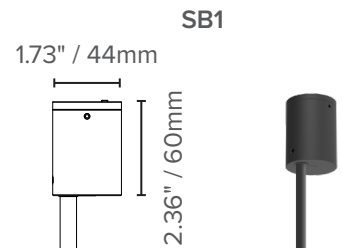
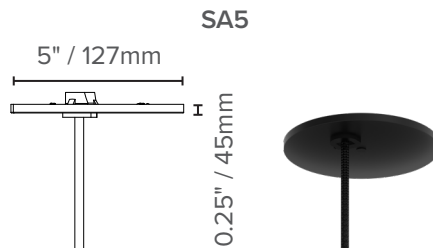
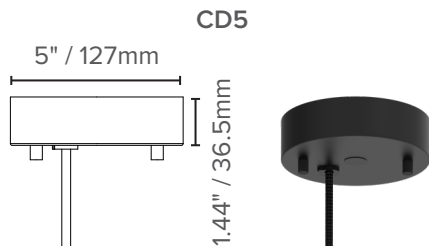

Luxxbox reserves the right to change the specification, material and colors at any time without notice. Standard warranty terms and conditions apply. All rights reserved © All dimensions and values on specification sheet are nominal. April 2024. LX-Kurtain-Spec Sheet V1.2



LUXXBOX USA INC × (P)+1 (415) 871 0448 × USA@LUXXBOX.COM
 LUXXBOX PTY LTD × (P)+61 7 3257 2822 × INFO@LUXXBOX.COM
 WWW.LUXXBOX.COM



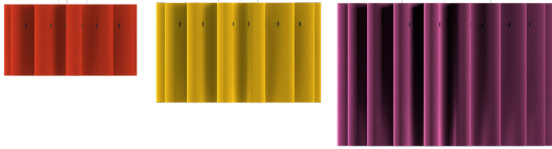

KURTAİN (LX-KU)

TYPE:

MATERIAL SPECIFICATIONS

MATERIAL:	WOOL	PET
COMPOSITION:	100% Virgin Wool (Camira Blazer Wool)	100% polyester fiber (98% post-consumer recycled + 2% masterbatch)
COLOR FASTNESS TO LIGHT:	4-6 (ISO 105 - B02)	ISO 105-B02-1994 Rating: 6-7
FIRE TEST:	AS1530 Part 3, AS3837, ISO5660, BS EN 1021-1&2 Cigarette and Match, BS 7176 Low Hazard, UNI 9175 Classe 1	AS 1530.3 / ISO 9705: Group 1 / GB8624 B1 / ASTM E-84-14 (Class A, FSI:20 - SDI:450) / BS EN13501-1:2007+A1:2009 (B-s1, d0)
ENVIRONMENTAL:	Renewable, Compostable, certified to EU Ecolabel & Indoor Advantage™ Gold	Global Recycled Standard 4.0, GreenTag Certification, GreenRate (Level A)
SOUND ABSORPTION:	BS EN ISO 10534-2: 2001 / Sound Absorption Coefficient	AS ISO 354 – 2006 / Noise reduction coefficient (NRC) = 0.85
THERMAL TRANSITION:	ASTM C518-2010. R- Value = 0.30 m ² K/W	
VOC EMISSIONS:	ASTM D5116 Rate: < 0.01 mg/m ² /hr (7 days)	

Please note some of these certificates will apply to specific colors.

PRODUCT ACOUSTIC PROPERTIES

Testing and post analysis procedures were carried out in accordance with the references detailed below:

AS ISO 354-2006 (R2016)	Acoustics—Measurement of sound absorption in a reverberation room
AS ISO 11654—2002	Rating of sound absorption—Materials and systems
ASTM C423-17	Standard Test Method for Sound Absorption and Sound Absorption Coefficients by the Reverberation Room Method
ASTM E795-16	Standard Practices for Mounting Test Specimens During Sound Absorption Tests
ISO 20189	Screens, furniture and single objects intended for interior use – Rating of sound absorption and sound reduction of elements based on laboratory measurements.

IMPERIAL SABINS

Frequency (Hz)	Sound Absorption Coefficient	SMALL (S)	MEDIUM (M)	LARGE (L)
125	0.06	0.07	0.13	0.26
250	0.33	0.40	0.70	1.43
500	0.73	0.88	1.55	3.17
1000	1	1.20	2.13	4.34
2000	0.96	1.15	2.04	4.17
4000	1	1.20	2.13	4.34

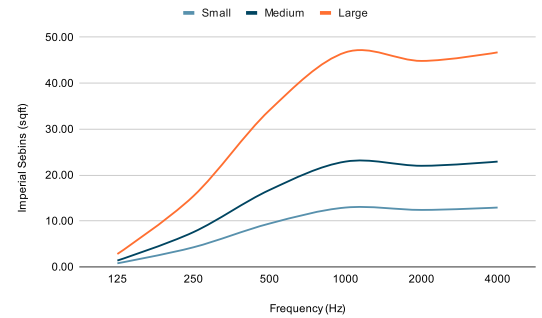

METRIC SABINS

Frequency (Hz)	Sound Absorption Coefficient	SMALL (S)	MEDIUM (M)	LARGE (L)
125	0.06	0.78	1.38	2.80
250	0.33	4.26	7.57	15.42
500	0.73	9.43	16.74	34.10
1000	1	12.92	22.93	46.72
2000	0.96	12.40	22.01	44.85
4000	1	12.92	22.93	46.72

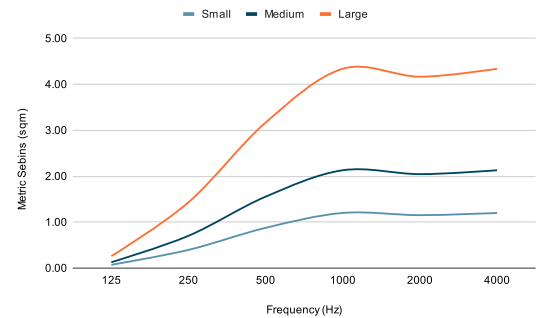

The Sabin data shown above is in accordance with the latest International Standards for the rating of sound absorption and reduction. This is different from the classic methodology, which includes the calculation of the Noise Reduction Coefficient (NRC), the Sound Absorption Average (SAA), the Weighted Sound Absorption Coefficient (**aw**) and the Sound Absorption Class (SAC). However, to make it easier to compare against other products, we are including that information on the table on the right, which was calculated using the Horizontal Floor Area method. Fully detailed test reports are available upon request.

NRC	0.70
SAA	0.64
aw	0.55
SAC	D

Luxbox reserves the right to change the specification, material and colors at any time without notice. Standard warranty terms and conditions apply. All rights reserved © All dimensions and values on specification sheet are nominal. April 2024. LX-Kurtain-Spec Sheet V1.2



LUXBOX USA INC × (P)+1 (415) 871 0448 × USA@LUXBOX.COM
 LUXBOX PTY LTD × (P)+61 7 3257 2822 × INFO@LUXBOX.COM
 WWW.LUXBOX.COM



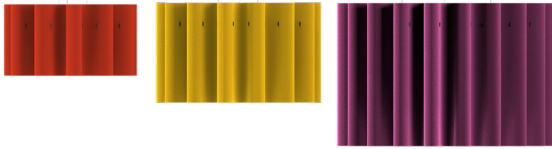

KURTAIN (LX-KU)

TYPE:

PRODUCT DIMENSIONS

TOP VIEWS

SIDE VIEWS

SMALL

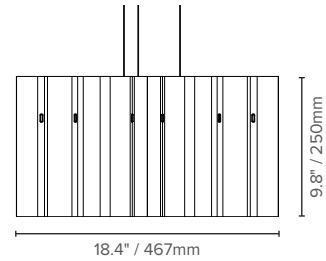
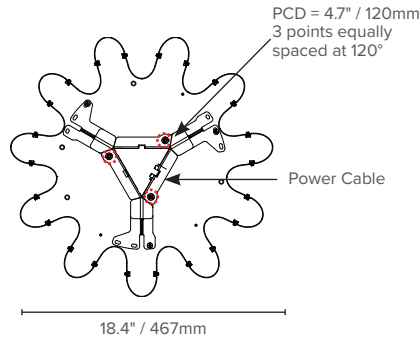

MEDIUM

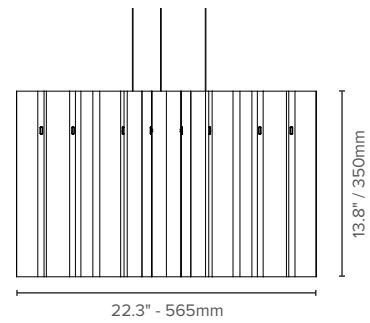
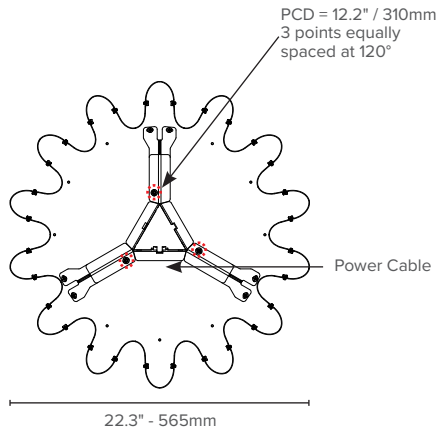

LARGE

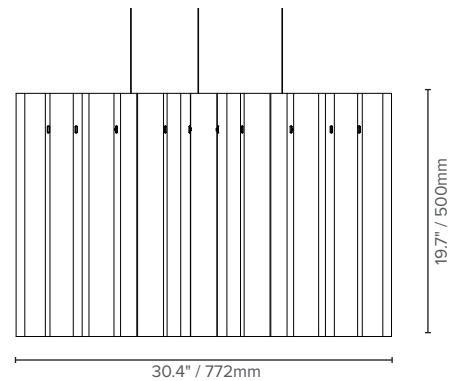
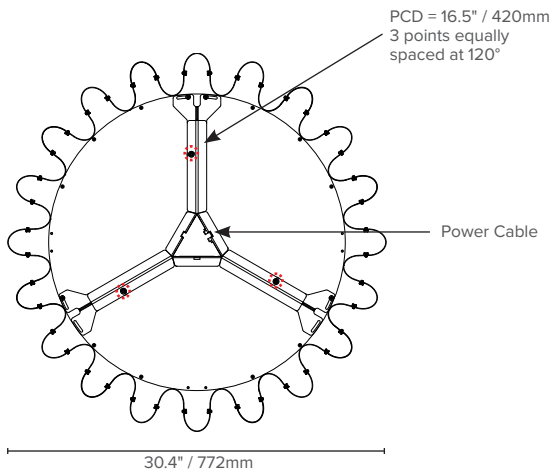

Luxxbox reserves the right to change the specification, material and colors at any time without notice. Standard warranty terms and conditions apply. All rights reserved © All dimensions and values on specification sheet are nominal. April 2024. LX-Kurtain-Spec Sheet V1.2



LUXXBOX USA INC × (P)+1 (415) 871 0448 × USA@LUXXBOX.COM
 LUXXBOX PTY LTD × (P)+61 7 3257 2822 × INFO@LUXXBOX.COM
 WWW.LUXXBOX.COM

