



CONO (LX-CN)

TYPE: LX-CN-

KEY FEATURES

- High-performance lumen output
- UGR<19
- Highly effective noise absorption
- 2 sizes and 77 wool colors
- 9' / 2.740mm length of black woven power cable per fixture
- IES / LDT photometric files available
- Acoustic baffle version available
- E27/E26 lamp holder option

OPTIONAL EXTRAS

- Additional options available upon request:
- POE
 - Bluetooth controller (US & EU only)
 - Tunable White output
 - White canopy and power cord

SIZE, OUTPUT AND WEIGHT

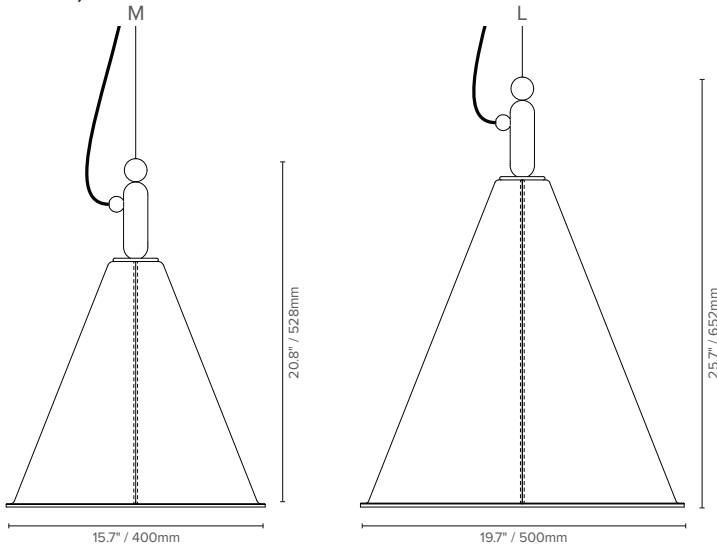

	AMBIENT LIGHT		TASK LIGHT	
	M / L	M / L	M / L	M / L
Delivered Lumen Output	540 lm		1169	
Wattage	10.8 W			
Efficacy	50 lm/W		108.2 lm/W	
CRI	90+			
UGR	<6		<8.8	
Beam Angle	62°		20°	
CCT	3000, 3500, 4000 K			

AMBIENT LIGHT

TASK LIGHT

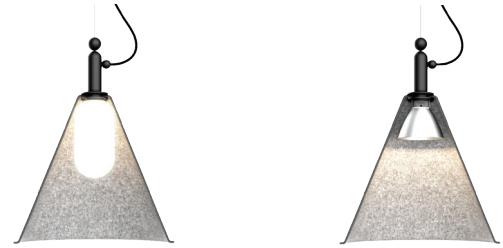

LUMINOUS INTENSITY DISTRIBUTION

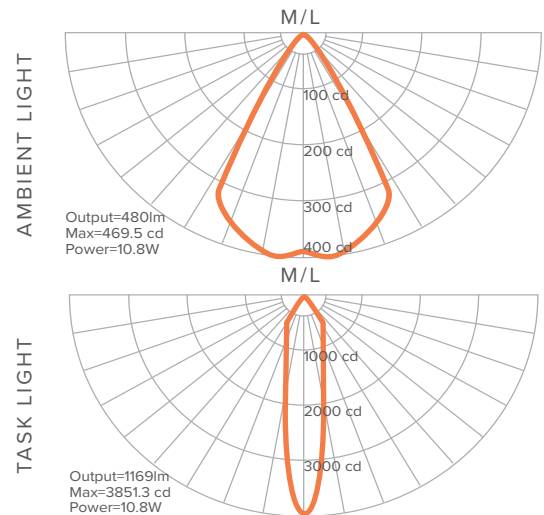

ORDER CODE

EXAMPLE: LX - CN - M - 1N - 40 - G - RD

(Luxbox Cono, Size M (15.7" x 20.8" / 400mm x 528mm), Wool option 1N, 4000K, Global 220-240V 1% dimming DSI/DALI, Remote driver)

PRODUCT CODE	SIZE	SHADE COLOR	COLOR TEMP	DRIVER / DIMMING	DRIVER TYPE
LX - CN	M	15.7" x 20.8" (400 x 528mm)	A30	UNV 0 - 10V - 1% dimming (120-277V) (North America only) G 1% dimming DSI/DALI (220 - 240V)**	CD Canopy concealed driver (UNV/North America only) RD Remote driver (UNV or G)
	L	19.7" x 25.7" (500 x 652mm)	A35		
CN		Use color codes as shown on pg. 2	A40		
			T30		
			T35		
			T40		
			*E26 E26 Lamp holder - 120V AC (North America only)		
			*E27 E27 Lamp holder - 220-240V AC (Global)		

* Please note the globe or driver will not be supplied with the E26/E27 option for this fixture. | ** Global (G) dimming type is available with Remote driver (RD) only

Luxbox reserves the right to change the specification, material and colors at any time without notice. Standard warranty terms and conditions apply. All rights reserved © All dimensions and values on specification sheet are nominal. May 2025. LX-Cono-Spec-Sheet_A4 v4.3



LUXBOX USA INC
(P)+1 (415) 871 0448 × USA@LUXBOX.COM
WWW.LUXBOX.COM





CONO (LX-CN)

TYPE: LX-CN-

WOOL UPHOLSTERED

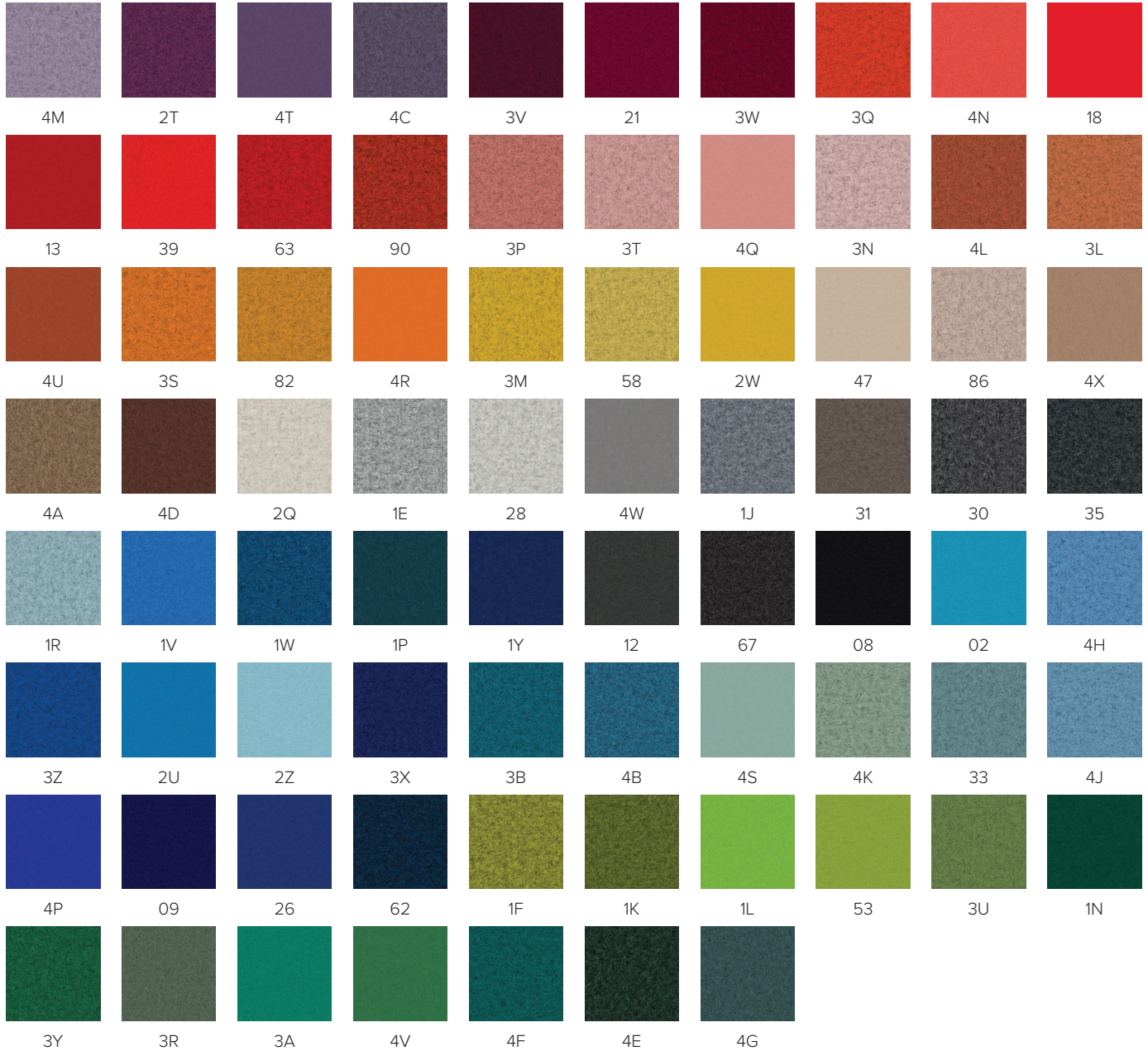

FELT FINISH

This version doesn't include any upholstery or stitching. To specify this option use color code SG (Silver Gray). In this instance, the inside of the shade will be in the same color/finish as the outside. See comparison between Wool Upholstered and Felt Finish below for reference.

NOTE: We used Wool Option 3S as an example. This would apply to all Wool options available.

Luxbox reserves the right to change the specification, material and colors at any time without notice. Standard warranty terms and conditions apply. All rights reserved © All dimensions and values on specification sheet are nominal. May 2025. LX-Cono-Spec-Sheet_A4 v4.3

FELT FINISH

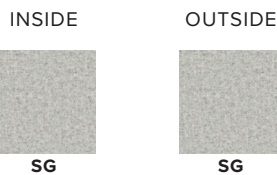

WOOL UPHOLSTERED

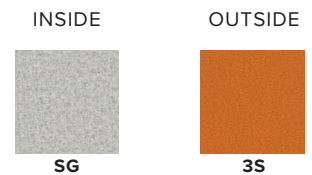

LUXXBOX USA INC
(P)+1 (415) 871 0448 × USA@LUXXBOX.COM
WWW.LUXXBOX.COM





CONO (LX-CN)

TYPE: LX-CN-

PHOTOMETRICS

LIGHT SOURCE SPECIFICATIONS

	AMBIENT LIGHT	TASK LIGHT
	M / L	M / L
Delivered Lumen Output	540 lm	1169
Wattage	10.8 W	
Efficacy	50 lm/W	108.2 lm/W
CRI	90+	
UGR	<6	<8.8
Beam Angle	62°	20°
CCT	3000, 3500, 4000 K	

AMBIENT LIGHT



TASK LIGHT



LUMINOUS INTENSITY DISTRIBUTION

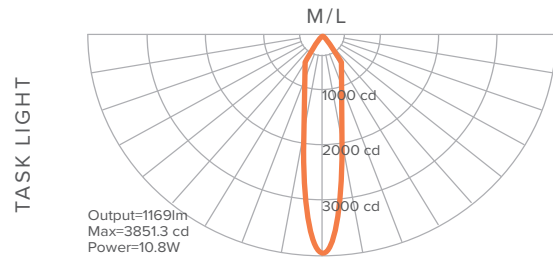
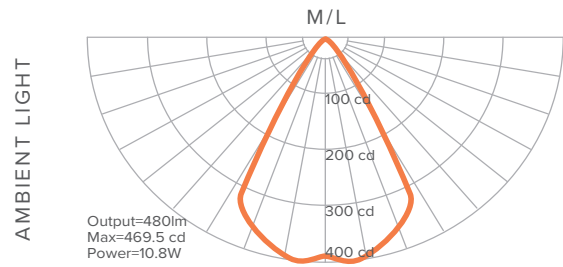

DRIVER INFORMATION

		WATTAGE	MAX VOLTAGE (V)	COMPLIANCE
UNIVERSAL (UNV) 0-10V - 1% dimming 110 - 277VAC (North America)	M / L	14.5 W	22-42VDC	
GLOBAL (G) 1% DSI DALI dimming 220 - 240VAC	M / L	14.5 W	22-42VDC	

CANOPY INFORMATION

Please note power cord and canopy will always be supplied in black unless specified otherwise.

	UNV (North America)		Global
	RD	CD	RD
M / L	SA6	CD6	SB2

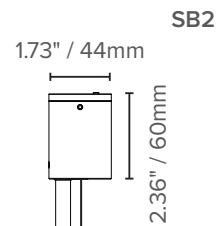
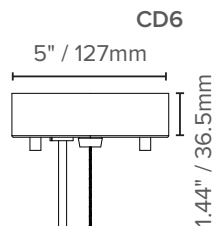
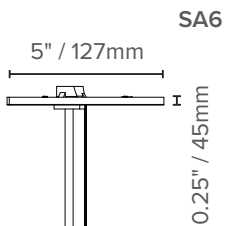

Luxxbox reserves the right to change the specification, material and colors at any time without notice. Standard warranty terms and conditions apply. All rights reserved © All dimensions and values on specification sheet are nominal. May 2025. LX-Cono-Spec-Sheet_A4 v4.3



LUXXBOX USA INC
(P)+1 (415) 871 0448 × USA@LUXXBOX.COM
WWW.LUXXBOX.COM





CONO (LX-CN)

TYPE: LX-CN-

MATERIAL SPECIFICATIONS

COLOR FASTNESS TO LIGHT:	ISO 105-B02:1994 Rating: 6-7
FIRE TEST:	AS 1530.3 / ISO 9705: Group 1 / GB8624 B1 / ASTM E-84-14 (Class A, FSI:20 - SDI:450) / BS EN13501-1:2007+A1:2009 (B-s1, d0)
ENVIRONMENTAL:	PET: GreenTag Certification / GreenRate: Level A
THERMAL TRANSITION:	ASTM C518-2010, R- Value = 0.30 m ² /K/W
SOUND ABSORPTION:	AS ISO 354 – 2006 / Noise reduction coefficient (NRC) = 0.55
VOC EMISSIONS:	ASTM D5116 Rate: < 0.01 mg/m ² /hr (7 days)

Please note some of these certificates will apply to specific colors.

PRODUCT ACOUSTIC PROPERTIES

Testing and post analysis procedures were carried out in accordance with the references detailed below:

AS ISO 354-2006 (R2016)	Acoustics—Measurement of sound absorption in a reverberation room
AS ISO 11654—2002	Rating of sound absorption—Materials and systems
ASTM C423-17	Standard Test Method for Sound Absorption and Sound Absorption Coefficients by the Reverberation Room Method
ASTM E795-16	Standard Practices for Mounting Test Specimens During Sound Absorption Tests
ISO 20189	Screens, furniture and single objects intended for interior use – Rating of sound absorption and sound reduction of elements based on laboratory measurements.

SABINS (FT ²)	Frequency (Hz)	Sound Absorption Coefficient	M	L
		125	0.16	1.04
	250	0.64	4.15	6.66
	500	0.40	2.59	4.16
	1000	0.58	3.76	6.03
	2000	0.65	4.21	6.76
	4000	0.78	5.06	8.11

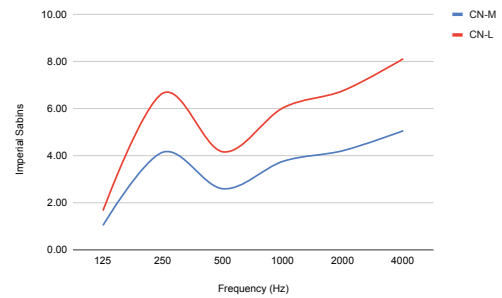

SABINS (M ²)	Frequency (Hz)	Sound Absorption Coefficient	M	L
		125	0.16	0.10
	250	0.64	0.39	0.62
	500	0.40	0.24	0.39
	1000	0.58	0.35	0.56
	2000	0.65	0.39	0.63
	4000	0.78	0.47	0.75

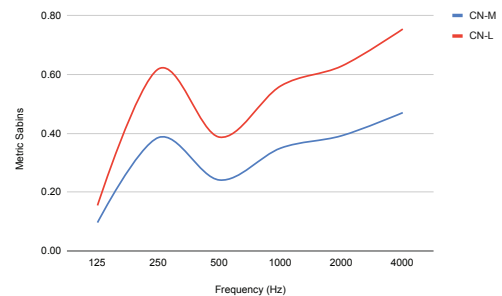

The Sabin data shown above is in accordance with the latest International Standards for the rating of sound absorption and reduction. This is different from the classic methodology, which includes the calculation of the Noise Reduction Coefficient (NRC), the Sound Absorption Average (SAA), the Weighted Sound Absorption Coefficient (α_w) and the Sound Absorption Class (SAC). However, to make it easier to compare against other products, we are including that information on the table on the right, which was calculated using the Horizontal Floor Area method. Fully detailed test reports are available upon request.

NRC	0.55
SAA	0.58
α_w	0.60

Luxbox reserves the right to change the specification, material and colors at any time without notice. Standard warranty terms and conditions apply. All rights reserved © All dimensions and values on specification sheet are nominal. May 2025. LX-Cono-Spec-Sheet_A4 v4.3



LUXBOX USA INC
(P)+1 (415) 871 0448 × USA@LUXBOX.COM
WWW.LUXBOX.COM





CONO (LX-CN)

TYPE: LX-CN-

PRODUCT DIMENSIONS

SIDE VIEWS

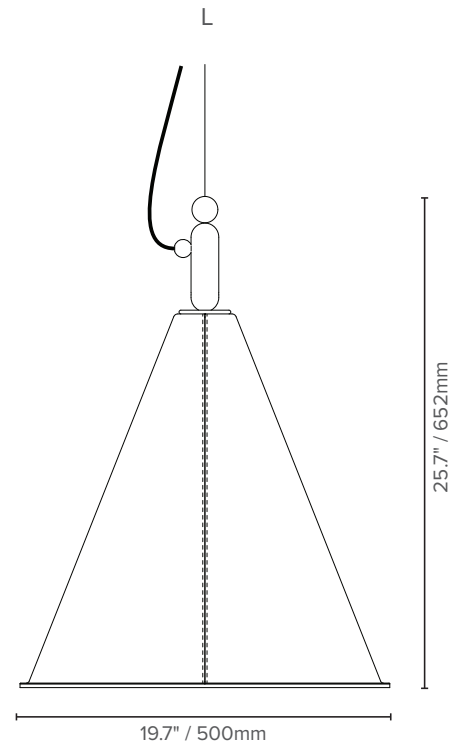
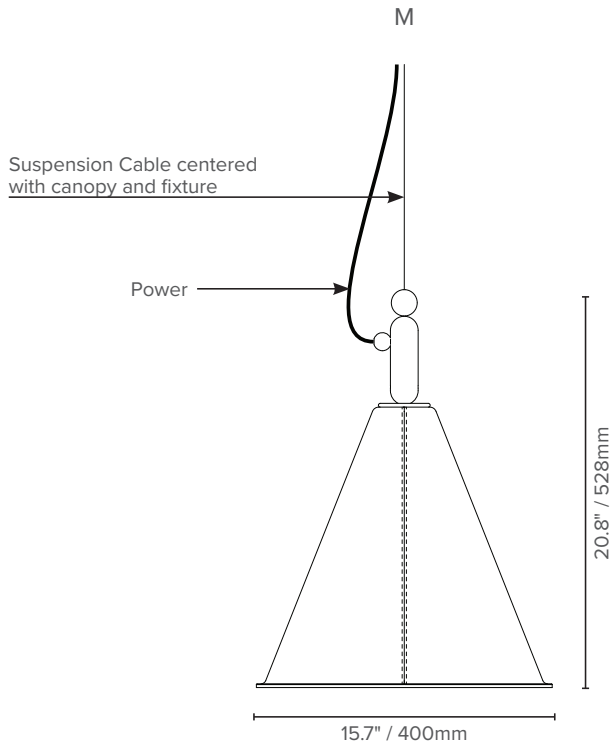

TOP VIEWS

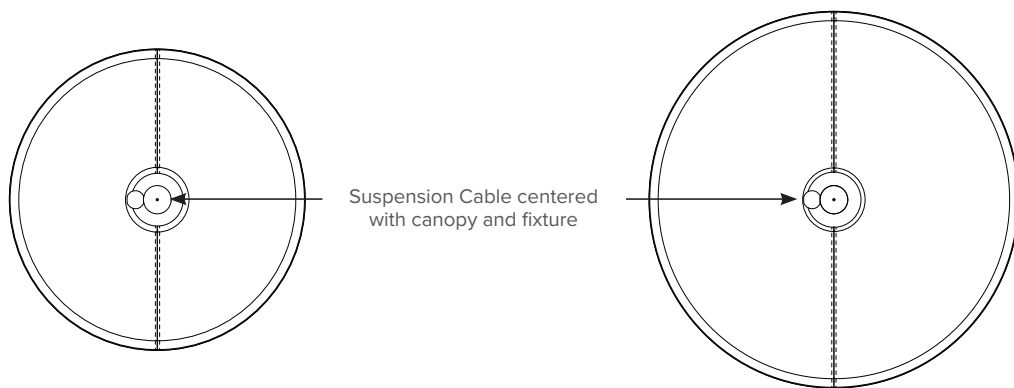

Luxxbox reserves the right to change the specification, material and colors at any time without notice. Standard warranty terms and conditions apply. All rights reserved © All dimensions and values on specification sheet are nominal. May 2025. LX-Cono-Spec-Sheet_A4 v4.3



LUXXBOX USA INC
(P)+1 (415) 871 0448 × USA@LUXXBOX.COM
WWW.LUXXBOX.COM

